

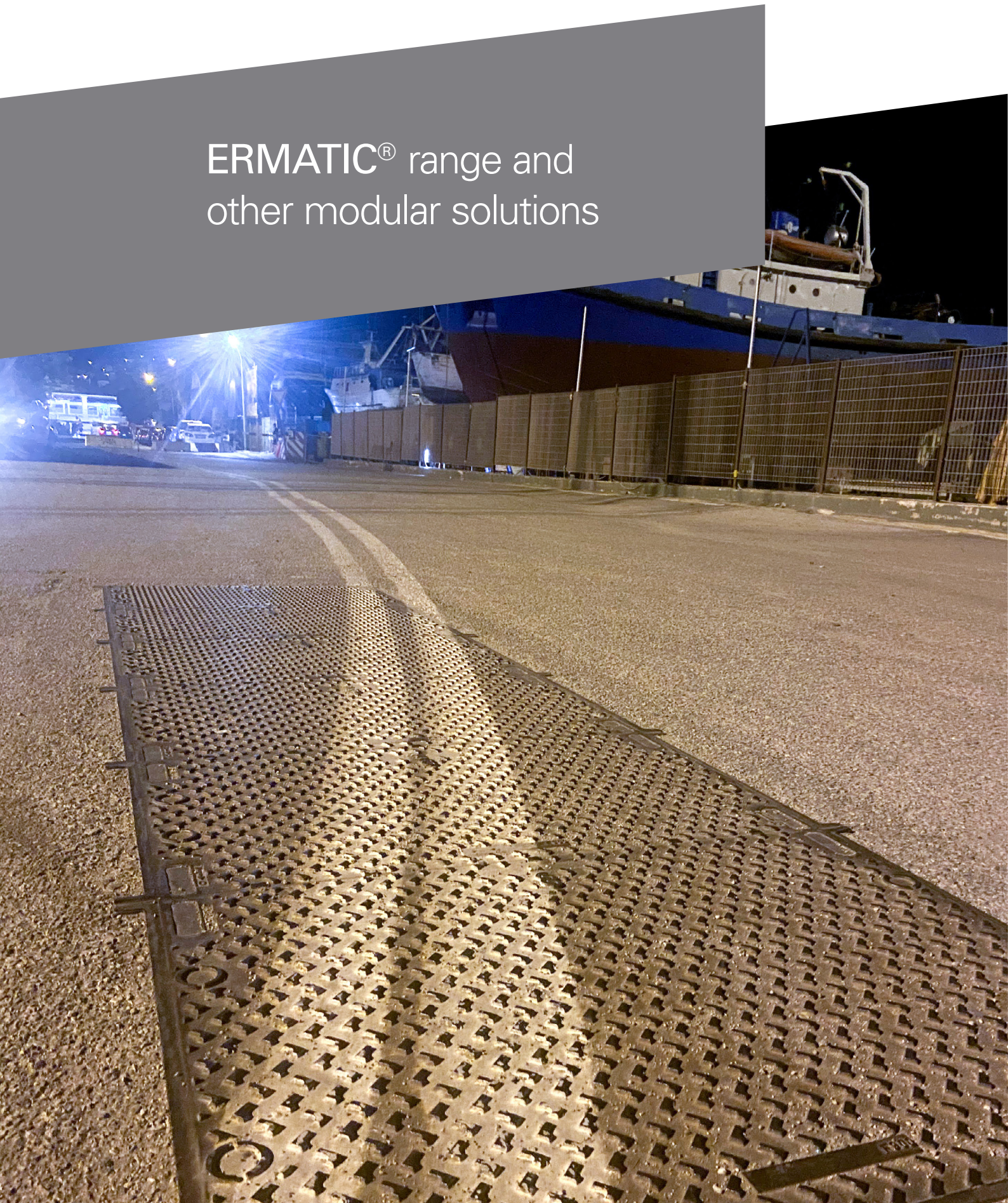

ej

ERMATIC® range and
other modular solutions



The Ermatic[®] range, the right solution

Worldwide, the ERMATIC[®] modular range is one of the most adaptable product ranges in the industry.

Some of the world's most prestigious infrastructure projects have selected the ERMATIC[®] range as their preferred solution: from airports, docks and tunnels to sewage, telecommunications and other utility networks.

With such a diverse range there is an ERMATIC[®] solution available for all your needs. Specifiers, contractors and end users choose the ERMATIC[®] range by **EJ**, because it is reliable, durable and serviced by the most professional technical support teams.

Thanks to decades of experience our research and collaboration give us the edge in creating the best infrastructure solutions available - solutions that lead the industry, act as best-in-class benchmarks, and satisfy the most demanding customer expectation.

EJ will continue to design and manufacture new and innovative solutions to meet tomorrow's networks.

ERMATIC® range and Other Modular Solutions Summary

	Page
Company introduction	2
Ermatic range - 1/2/3 part covers	
B125	18
C250	22
D400	26
E600	30
F900	34
Ermatic range - Continuous duct covers	
Pre-sales technical assistance	40
B125	42
C250	46
D400	50
E600	54
F900	58
Ermatic range - Covers with removable beams	
Pre-sales technical assistance	64
B125	66
C250	70
D400	74
E600	78
F900	82
Ermatic® range - Technical file	
Technical assistance with installations	88
Installation recommendations	90
Recommendations for the concrete infill of covers	94
Operation of Ermatic covers	95
Specification details for bills of quantities	96
Other modular solutions	
CT4B	
Introducing the CT4B range	98
1/2/3 parts covers concrete infill	102
Continuous duct covers concrete infill	104
Multiple covers with removable beams concrete infill	106
Installation recommendations	108
CT4S	
Introducing the CT4S range	112
CT4S...075 series	
Solid top 1/2/3 parts covers	116
Solid top continuous duct covers	116
Solid top covers with removable beams	118
Installation recommendations	120
CT4S...100 series	
Solid top 1/2/3 parts covers	122
Solid top continuous duct covers	122
Solid top covers with removable beams	124
Installation recommendations	126
Aquera®, the modular range of gratings	
A new modular range of gratings and frames	130
1/2/3 parts gratings and frames	134
Continuous duct gratings and frames	136
Multiple gratings with removable beams	138
Installation recommendations	140
Optional accessories for all modular products	
Safety Grids and Safety Railings	144

Ensure the well-being and safety of your fellow citizens

EJ, are global leaders in the design, manufacture and distribution of infrastructure access solutions.

Covering water and sewerage networks, rainwater harvesting, telecommunications and other public utility networks has been **EJ** expertise for decades.

Access your underground infrastructure in cities, railway stations, industries, water & wastewater treatment plants, airports, ports, exhibition halls, tunnels with EJ **access covers and drainage solutions**.

The group's strengths: achieving the highest quality standards, guaranteed safety and respect for the environment.

Its resources: qualified and committed employees.



EJ, 140 years of expertise to service your needs

By adopting a strategy of continuous investment in our production sites, we confirm our commitment to remain a world leader in infrastructure access solutions.

Access solutions to underground networks and asset security specialist, EJ is able to offer you the most appropriate solutions with the most relevant material to suit your needs.

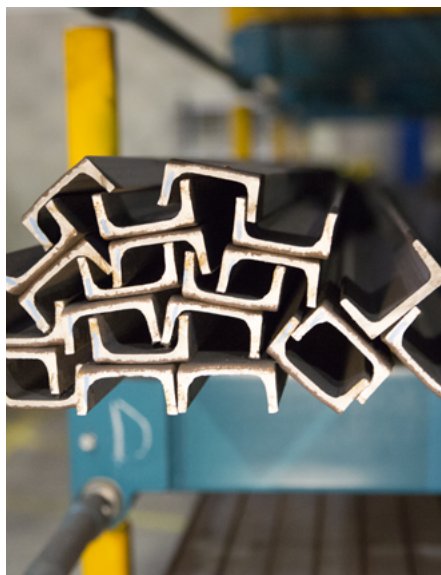

High-performance, resistant and elastic ductile iron for all your projects

Galvanized steel and aluminum, two high performance materials, suitable for your special projects

The **composite material**, innovative, light, insensitive to corrosion, for your specific applications

Citizen group, eco-responsible

Our approach to social and environmental responsibility has been rewarded with a gold medal by EcoVadis. Our production site in Picardie ranks in the top 5% of the most efficient companies across all sectors.



Picardie - France, the Saint Crépin Ibouvillers foundry in Oise, employees, production capacity of 100,000 tonnes, 42 hectares. Management systems certified ISO 9001, ISO 14001, ISO 45001 and ISO 50001 for the management of quality, environment, hygiene, safety and energy.

To be "Eco-Responsible" is not simply an expression but a guiding principle that features predominantly in our daily activities:

- **Quantity and nature of materials used**

Our innovative products require the use of less material, while maintaining structural integrity and load capacity. In addition, our cast iron products are made from at least **92% recycled materials**.



- **Reducing and controlling our emissions**

We ensure the use of the best available pollution control techniques to **reduce** and **control our emissions**.

- **Waste reduction, sorting and recovery**

Our sites have set up waste sorting at source. EJ favours treatment and recovery channels for waste specific to the activity as well as for other waste.

- **Third-party control and commitment to continual improvement**

Our plants use processes and management systems to minimise their impact on the environment. For example, with ISO 50001 certification, the Picardie foundry is committed to reducing its energy consumption.





Ardennes - France, our manufacturing site for galvanized or stainless steel devices, 71 employees. Management systems certified ISO 9001, ISO 14001, OHSAS 18001 for the management of quality, environment, health and safety.



Birr -Irlande, with both a composite production site and a fabricated steel facility. Management system certification includes ISO 9001, ISO 14001 and ISO 45001 for quality management, environment, health and safety.



Boppard - Deutschland - Unsere Fertigung am Rhein, Deutschland: insgesamt 96 Mitarbeiter – Entwicklung und Fertigung von Stahl und Edelstahlösungen. Managementsystem zertifiziert nach ISO 9001 für Qualitätsmanagement und ISO 45001 für Arbeitsschutzmanagement.

Our certifications



Picardy Foundry*

ISO 9001: Quality Management System
 ISO 14001: Environmental Management System
 ISO 45001: Health Management System and Safety at work
 ISO 50001: Energy Management System

Ardennes Manufactory

ISO 9001 : Quality Management System
 ISO 14001: Environmental Management System
 ISO 45001 : Health Management System and Safety at work

***Birr Manufactory**

ISO 9001 : Quality Management System
 ISO 14001: Environmental Management System
 ISO 45001 : Health Management System and Safety at work

***Boppard Manufactory**

ISO 9001 : Quality Management System
 ISO 45001 : Health Management System and Safety at work

*Bureau Veritas Certification + 33 (0) 1 41 97 00 60
 BSI, Kitemark Court, Davy Avenue, Knowlhill, Milton Keynes MK5 8PP. + 44 345 080 9000
 DNV GL Business Assurance Zertifizierung & Umweltgutachter GmbH +49 201 7296-555



The modular solution

Click here to watch ERMATIC® videos



Covers with multiple beams



Continuous duct covers



Grease application to machined surfaces



Cover handling

ERMATIC® is a comprehensive and highly specified range of access covers for a wide variety of underground services.

- **Sewerage:** inspection pits for sludge chambers, access shafts for large plants, etc.
- **Telecommunications:** cable jointing chambers, etc.
- **Electricity:** lighting, signals, transformer pits, cable joint boxes, etc.

In the following environments:

- **Airports and ports**
- **Railways**
- **Tunnels (see page 11)**
- **Power stations**
- **Water treatment and purification plants**
- **Manufacturing plants**
- **Industries**
- **Exhibition centres, leisure parks, stadiums, etc.**

ERMATIC® products assure protection against damage, debris or aggressive chemicals, and allow designers to conceal underground services, maximising productive use of the unobstructed surface.

Environment, security, ergonomics, the ERMATIC® range benefits from the advanced technology of EJ :

- **aesthetics of the project is enhanced:** the covers can be recessed to receive a similar material to the surround,
- **rapid and easy access for maintenance and the network deployment,**
- **security reinforced** by the strength and stability of the covers.

Modular construction

The use of modular elements gives a vast range of sizes. Frame elements (side frames and end plates) are assembled using bolts and aluminium joints to provide linear openings for even the longest ducts.

Above clear opening spans of 1200 mm, ERMATIC® units use removable beams supported in boxes which are fixed to the frames. This allows the construction of units to suit the largest openings.

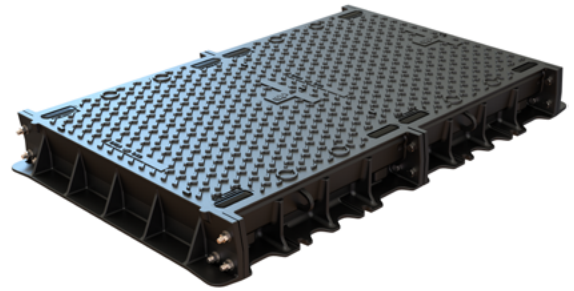

1/2/3 covers unit

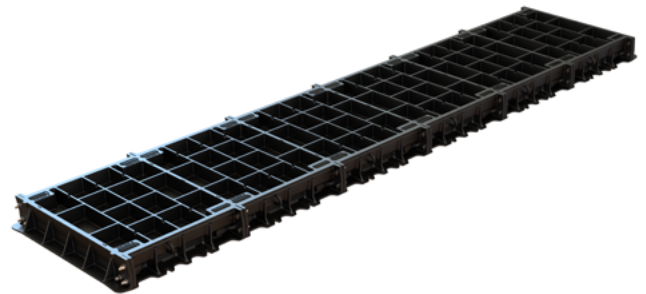

continuous duct cover

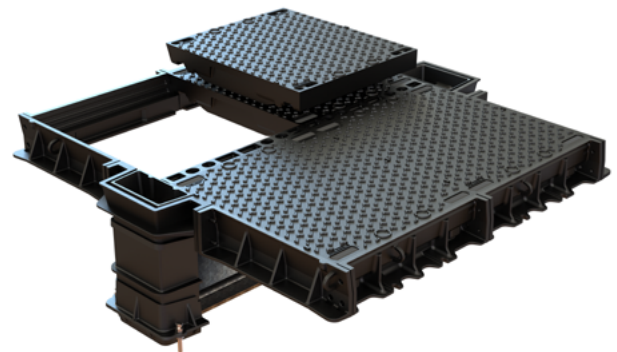

cover with removable beams

Covers and frames conformity

Requirements of standard EN124 :2015 :2015

Determines the following characteristics of covers and frames:

- The principles of construction: frame depth, depth of insertion, seatings, surface condition etc.
- The material used for the manufacture of covers
- The testing regime: test loads and permanent set limits
- The minimum requirement for the quality system (at least equivalent to ISO 9002)
- The clear identification of the required third party certification body on the products.



EN124 :2015 :2015 compliance of ERMATIC® range

- All ERMATIC® covers are designed to meet all the requirements of the EN124 :2015 :2015 standard.
- All ERMATIC® covers are manufactured from ductile iron according to ISO 1083 and EN 1563.
- All solid top covers and recessed B125/C250/D400/E600 covers are tested in the as-cast condition and meet all the test criteria of the EN124 :2015 standard. ER9R recessed covers meet the resistance characteristics when filled with concrete (in compliance with the EN124 :2015 standard and our recommendations - refer to our technical file at the end of this ERMATIC® section). ER6R...120 is factory filled to meet its class of resistance
- Loading and conformity certificates in accordance with the requirements of EN124 :2015
- The dimensions of removable beams in multiple units are derived from the following French specifications:

· ERMATIC® B125:	Loading 500 daN/m ²
· ERMATIC® C250:	CCTG volume 61 - clause 2
· ERMATIC® D400:	CCTG volume 61 - clause 2
· ERMATIC® E600/F900:	ADP and STBA
- **Upon request, we can supply Eurocode 3 part 2 compliant beams.**
- The design and manufacture of Ermatic covers is undertaken within one facility operating a quality system certified by third party to ISO 9001.

The EN124 :2015 standard is limited to covers with a clear opening dimension ≤ 1000 mm.

Consequently, units above this dimension, particularly those that use removable beams, are outside the scope of EN124 :2015. However, some 1,2 and 3 part solid top units, from which multiples are constructed, carry third party certification to conform with the requirements of EN124 :2015 (please consult us for further information).

Products characteristics are dependent upon correct installation in accordance with the recommendations as seen in our technical file at the end of this ERMATIC® section.

Drawings, photos and weights are given as an indication without any contractual value. Our policy is one of continuous improvement, we reserve the right to modify product specifications without prior notice.

Covers and frames conformity

The EN124 :2015 standard introduced the idea of groups and minimum class, depending on the place of installation

Group 1	Group 2	Group 3	Group 4	Group 5	Group 6
CLASS A15 MINIMUM	CLASS B125 MINIMUM	CLASS C250 MINIMUM	CLASS D400 MINIMUM	CLASS E600 MINIMUM	CLASSE F900
<p>Group 1 (class A 15 minimum) Design load: 15kN Area of installation: Areas which can only be used by pedestrians and pedal cyclists.</p>	<p>Group 2 (class B125 minimum) Design load: 125kN Area of installation: Footways, pedestrian areas and comparable areas, car parks or car parking decks.</p>	<p>Group 3 (class C250 minimum) Design load: 250kN Area of installation: For gully tops installed in the area of kerbside channels of roads which when measured from the kerb edge, extend a maximum of 0.5 m into the carriageway and a maximum of 0.2 m into the footway.</p>	<p>Group 4 (class D400 minimum) Design load: 400kN Area of installation: Carriageways of roads (including pedestrian streets), hard shoulders and parking areas for all types of road vehicles.</p>	<p>Group 5 (class E600 minimum) Design load: 600kN Area of installation: Areas imposing high wheel loads e.g. docks, aircraft pavements.</p>	<p>Group 6 (class F900 minimum) Design load: 900kN Area of installation: Areas imposing particularly high wheel loads e.g. docks, aircraft pavements.</p>

Recommended **ERMATIC®**

ERMATIC® B125	ERMATIC® C250	ERMATIC® D400	ERMATIC® E600	ERMATIC® F900
Area of installation: Group 2 and lower.	Area of installation: Group 3 and lower.	Area of installation: Group 4 and lower.	Area of installation: Group 5 and lower.	Area of installation: Group 6 and lower.

The selection of the appropriate class is the network designer's responsibility. Where there is a doubt, the higher class should be used.

Special features

Stability with machined contact faces

The horizontal and vertical faces of the cover and frame are machined to give metal-to-metal contact between the seating faces, within a tolerance of 0.2 mm.

When correctly installed, ERMATIC® products are non-rocking, silent under traffic and prevent the ingress of dust and debris. In addition, the unit will have virtually no lateral movement.

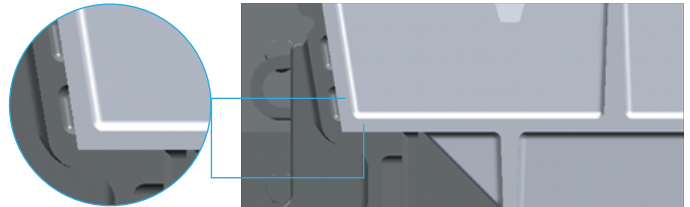

Machined seating protection with ribs extending at the underside of the cover

To protect the machined seatings, the reinforcing ribs are deeper than the cover. This also prevents any greased surfaces coming into contact with the floor (except for some B125 recessed covers).

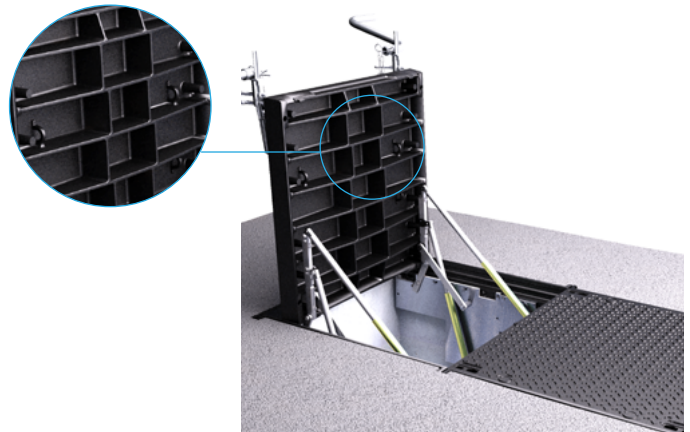

Sealing for water and odour resistance

The addition of a film of grease to the machined contact faces of the cover and frame renders the ERMATIC® cover water resistant under normal rainwater conditions.

Always levelled with adjusting bolts on the side frame

In order to facilitate the levelling of ERMATIC® systems, adjusting bolts can be provided with the products. These bolts will allow, where necessary, a perfect adjustment to the final level and correct any possible defects of the civil work.

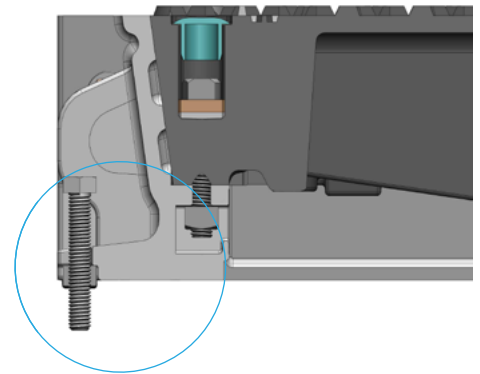

Network protection with cover security locking

In order to secure the network, you can specify a standard or enhanced security bolting system.

D400: we provide as standard a **CHC** bolting system to help during installation. For E600 and F900 products **locking is recommended** for the same reasons.

Standard locking VCHC

- Standard head

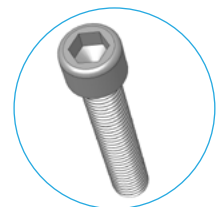

Security locking VOTC

- OTC head
- Reversed threading

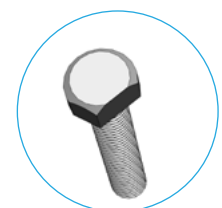

Special features

Types of surface finish available

Designed for a wide range of applications, the ERMATIC® range offers a choice of covers to suit every specification of performance and/or appearance.

Solid top cover with uniform anti-slip surface

This cover offers unequalled performance whilst being lighter than recessed covers of a comparable size when filled with concrete. Installation costs are reduced and the performance is not influenced by the quality of the concrete infill.

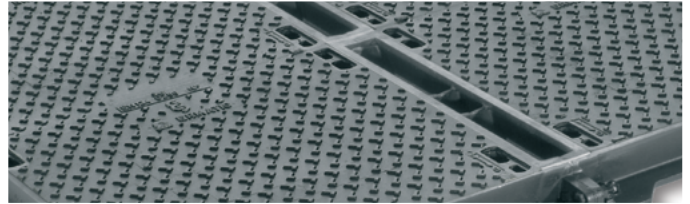

Cover recessed for concrete infill

In classes B125 and C250, the ribs are positioned below the surface of the cover to permit the installation of thin paving. This type of cover is particularly suited to large openings where aesthetic considerations are a priority. The concrete infill is undertaken in accordance with the requirements of EN124-2 and with EJ specifications detailed in this brochure (see our technical file).



Other types

Small element paving

Covers recessed for small element paving for pedestrian areas



Central removable plug

Cover with central removable plug.



Ermatic in tunnels

Tunnels may require the use of special materials to withstand certain environments that have become corrosive due to de-icing salt remaining in place for long periods of time. EJ has developed a synthetic seal solution specifically designed to withstand this environment. Request this option for these kinds of environments to maintain the performance of the product.



Hinged and assisted opening on the covers

Hinged and assisted opening system on the covers

All solid top ERMATIC® covers (from Class B125 to class F900) are available with a hinge and assistance opening system.

Please enquire.

Note: for duct and beam multiple covers, a technical assistance is provided on site.

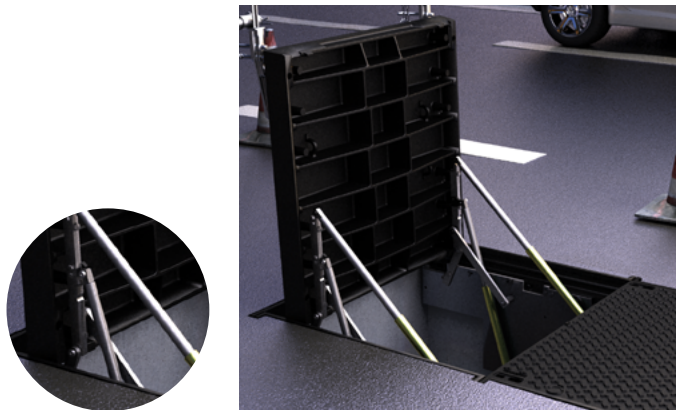

Options

Where appropriate: choice of coil spring or gas struts (standard or stainless steel)
Please consult us for more details.

Operation

Opening of hinged covers

Hinged covers always open in sequence
as marked on the covers.



Handling with ease

Click to watch the video



handling of covers

Handling with ease

Covers slide in and out of the frame along greased, machined seatings, providing a metal to metal with little friction and requiring no vertical lift.

ERMATIC® key

- Ergonomically designed to provide the lowest effort thanks to the leverage effect.
- Fitted with jacking bolts to break the seal.

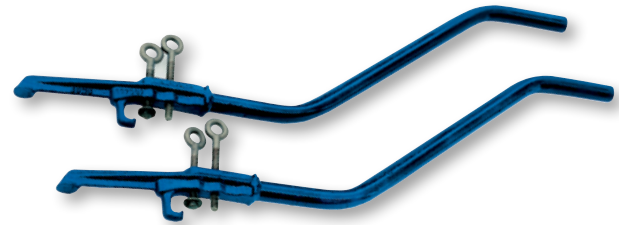

blocking bolt

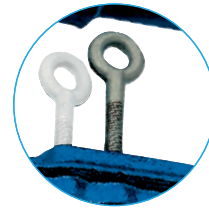

jacking bolt



Universal keyways

For use with many different types of common lifting keys. Fitted with polyethylene blanking plugs to prevent the entry of debris or concrete.



Selection guide

In order to select the correct ERMATIC® covers, it is necessary to consider

- The required surface condition of the covers: recessed or solid top.
- Loading classes and their application
- The characteristics of the chamber or duct to be covered,
- The safety for operators and equipments (locking, safety grids, etc.)

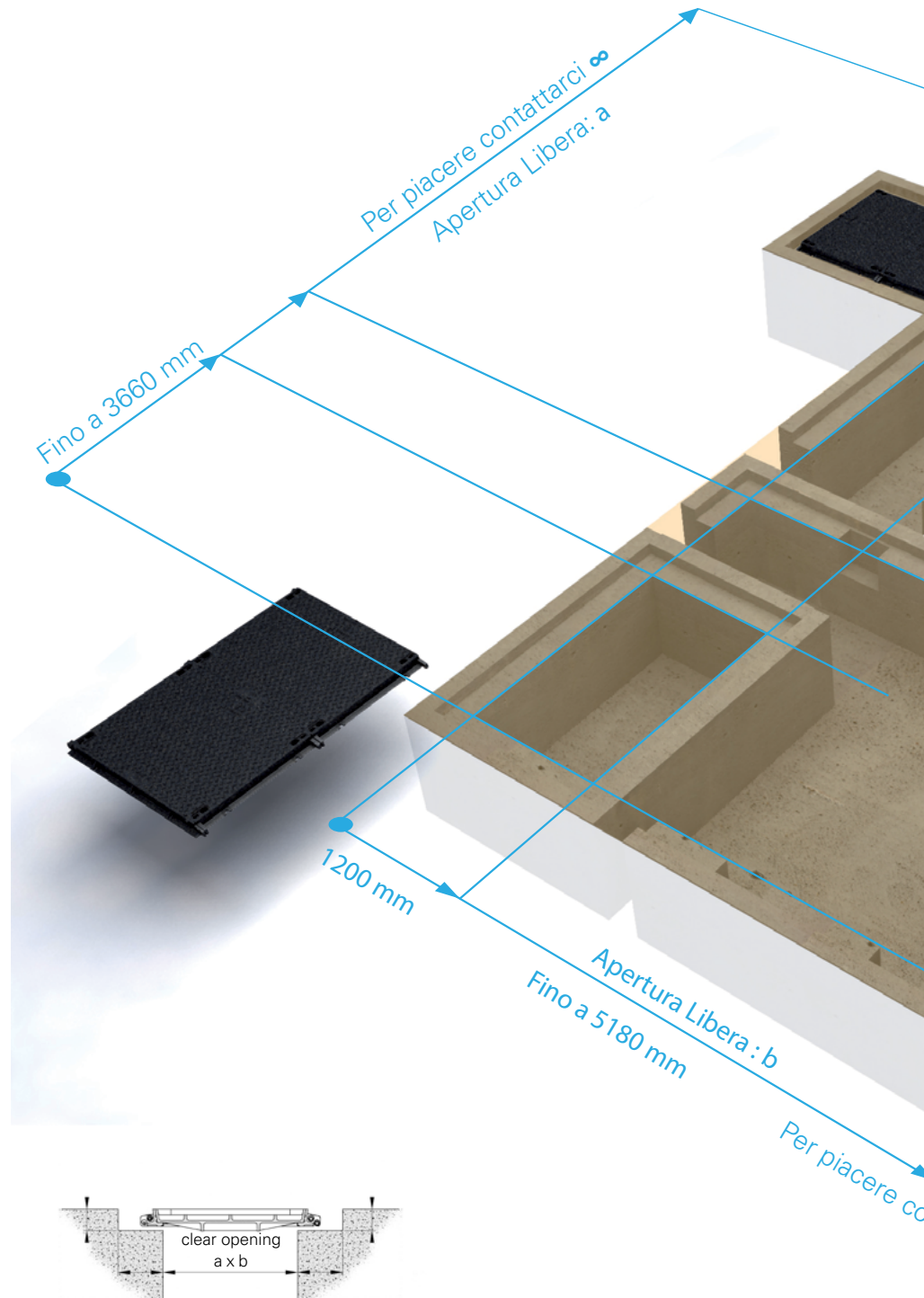

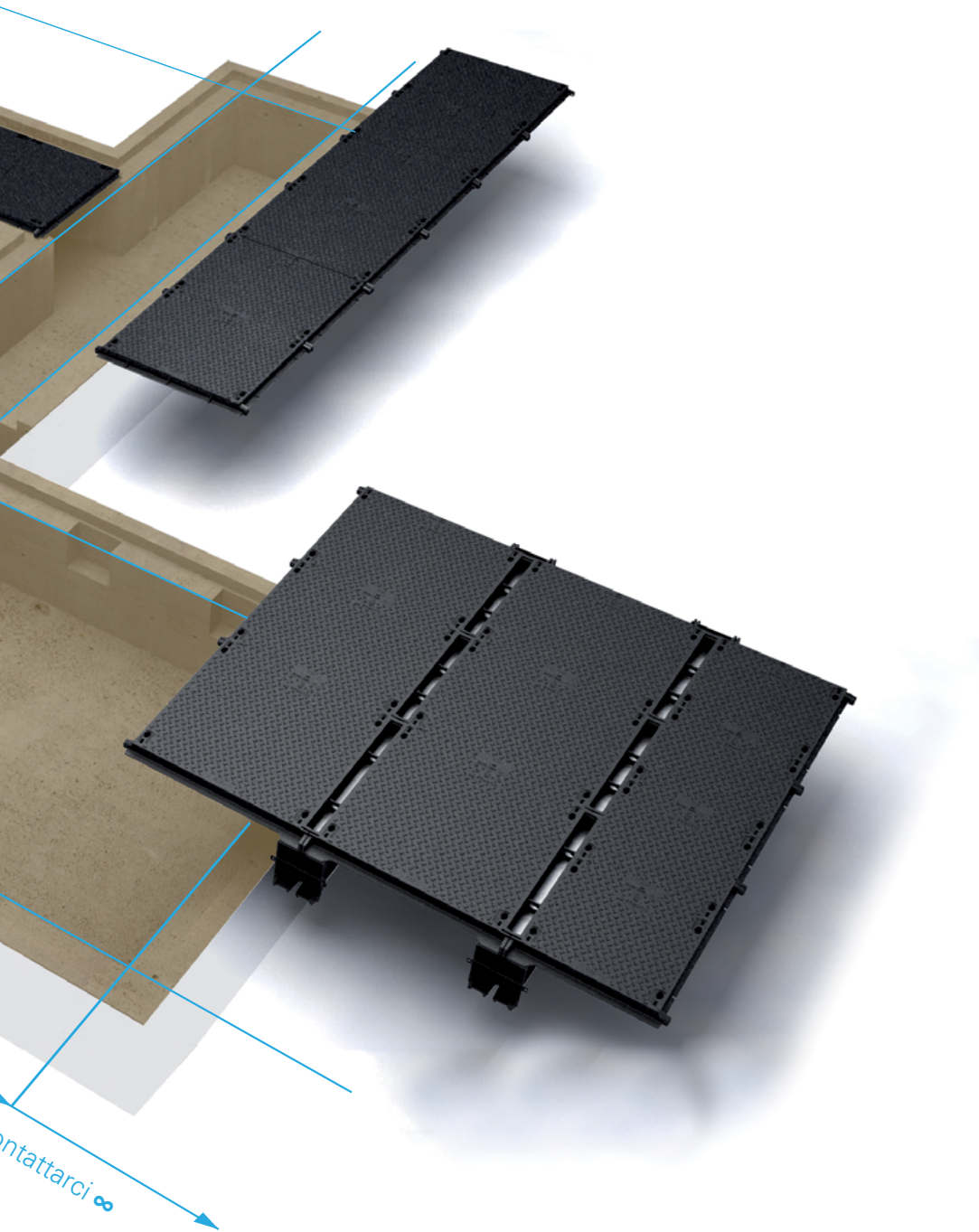

Site References

Country	Place of installation	Network type	Project
Barhain	Housing Project	Water Supply	Salmabad Electricity & Water
Belgium	Airport	Sewage	Kortrijk-Wevelgem Airport
Belgium	Airport	Telecom & Cables	Brussels Airport Zaventem
Belgium	Data Centre	Telecom & Cables	Google Baudour
Belgium	Various	Telecom / Fiber	Proximus
Canada	Airport	Sewage	Montreal Airport
France	Industry	Electricity/Signals	Liebherr in Colmar
France	Exhibition Hall	Various	Louvre Museum technical gallery
France	Railway	Water Conveyance	Sncf
France	Tunnel / Technical Area	Various	Violey Tunnel
Germany	Port	Telecom & Cables	Hamburg Port
Italy	Airport	Various	Palermo Airport
Italy	Municipal Casting	Water Supply	Verona
Italy	Municipal Casting	Various	Dal Molin Military Base
Italy	Municipal Casting	Various	Rimini Hospital
Italy	Municipal Casting	Street Furniture	Milan Metro Station
Italy	Municipal Casting	Street Furniture	Venice "Arsenale"
Saudi Arabia	Airport	Sewage	Jeddah Airport
Spain	Industry	Various	Ikea Store
Spain	Port	Electricity/Signals	Valence Port
Spain	Municipal Casting	Sewage	Tenerife Water Department
Spain	Municipal Casting	Various	Tenerife Water Department
Switzerland	Airport	Telecom / Fiber/Cable	Zürich Airport
Switzerland	Tunnel Technical Area	Electricity/Signals	Gothard Railway Tunnel
UAE	Airport	Sewage	Dubai Airport
UAE	Infrastructure Networks	Various	Al Sowwah Island
UK	Airport	Sewage	Manchester Airport Runway II
UK	Industry	Sewage	Northumbrian Water
UK	Industry	Sewage	Birmingham
UK	Industry	Telecom / Fiber/Cable	New BBC Headquarters
UK	Industry	Telecom / Fiber/Cable	Canary Wharf
UK	Tunnel Technical Area	Electricity/Signals	Channel Tunnel
UK	TV / Cinema Studios	Electricity/Signals	Salford Media City
UK	Tunnel Technical Area	Sewage	Severn Trent Water

Ermatic® range 1/2/3 parts covers

Ermatic B125

- 18 Recessed covers for concrete infill
- 20 Covers with anti-slip surface

Ermatic C250

- 22 Recessed covers for concrete infill
- 24 Covers with anti-slip surface

Ermatic D400

- 26 Recessed covers for concrete infill
- 28 Covers with anti-slip surface

Ermatic E600

- 30 Recessed covers for concrete infill
- 32 Covers with anti-slip surface

Ermatic F900

- 34 Recessed covers for concrete infill
- 36 Covers with anti-slip surface

The Ermatic range is designed to cover access and inspection chambers for a wide variety of underground services. The range consists of standard units made up of one, two or three covers within a frame. This section covers a wide variety of clear opening sizes from 300 x 300 mm up to 3040 x 1200 mm. Cover types include **recessed** for **concrete infill**, **recessed** for **block paving** and **solid top with anti-slip surface**, in all loading classes from B125 to F900.

Options for larger dimension openings include:

- Duct covers
- Covers suitable for the removal of large items of plant or machinery

Please refer to the **Duct Covers** and **Beamed Multiple Covers sections**.

1/2/3 part covers recessed for concrete infill B125

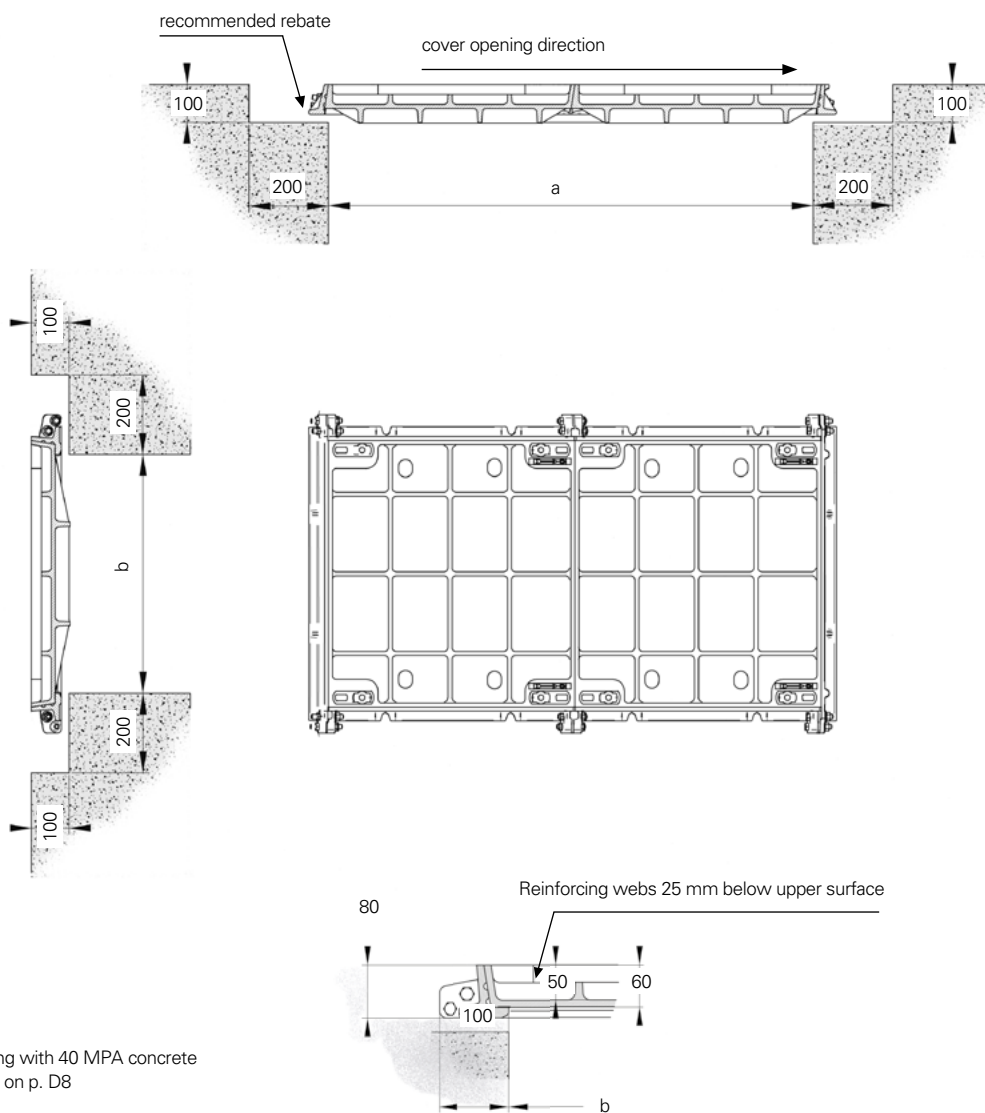

Dimensions in mm
Cover recessed for filling with 40 MPA concrete
See recommendations on p. D8

1/2/3 part covers recessed for concrete infill B125

Area of installation

Footways, pedestrian areas and comparable areas, car parks or car parking decks.
Group 2 and lower as per EN124.

Specification

- ERMATIC B125 access Cover and frame
- Cover recessed for concrete infill
- Clear opening (a x b) in mm: **reference ER2R** (a x b) in cm
- Machined vertical and horizontal contact faces
- Ductile cast iron according to ISO 1083 and EN 1563.
- Quality assurance by third party certification to ISO 9001

Options

- Locking by 4 stainless steel bolts
 - Standard locking (VCHC)
 - Security locking (VOTC)
- Level adjusting bolts (see detail on p.10)
- Safety grids (see detail on pages 144-145)

Handling

- Pair of EM keys (weight 8 kg per pair) (see detail on p.13)
See handling details in the attached technical file

Technical file (see pages 87 - 96)

- Installation recommendations
- Rebate preparation
- Installation and shuttering
- Concrete infill
- Operation of covers
- Maintenance
- Full technical specification

Options

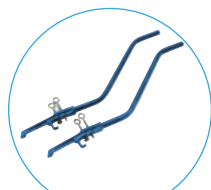

Handling key

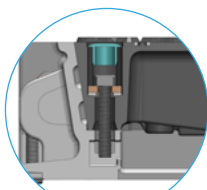

CHC locking

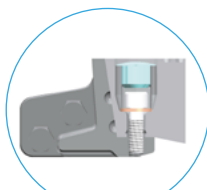

OTC locking

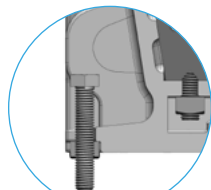

Levelling bolts



Safety grids



Synthetic seal for corrosive environments

clear opening axb (mm)	overall frame length x width x height (mm)	number of covers	reference
750 x 300	860 x 500 x 80	■	ER 2R 075 030
1520 x 300	1630 x 500 x 80	■ ■	ER 2R 152 030
2290 x 300	2400 x 500 x 80	■ ■ ■	ER 2R 229 030
450 x 450	560 x 650 x 80	■	ER 2R 045 045
600 x 450	710 x 650 x 80	■	ER 2R 060 045
900 x 450	1010 x 650 x 80	■	ER 2R 090 045
920 x 450	1030 x 650 x 80	■ ■	ER 2R 092 045
1070 x 450	1180 x 650 x 80	■ ■	ER 2R 107 045
1220 x 450	1330 x 650 x 80	■ ■	ER 2R 122 045
1390 x 450	1500 x 650 x 80	■ ■ ■	ER 2R 139 045
1520 x 450	1630 x 650 x 80	■ ■	ER 2R 152 045
1540 x 450	1650 x 650 x 80	■ ■ ■	ER 2R 154 045
1820 x 450	1930 x 650 x 80	■ ■	ER 2R 182 045
1840 x 450	1950 x 650 x 80	■ ■ ■	ER 2R 184 045
2140 x 450	2250 x 650 x 80	■ ■ ■	ER 2R 214 045
2440 x 450	2550 x 650 x 80	■ ■ ■	ER 2R 244 045
2740 x 450	2850 x 650 x 80	■ ■ ■	ER 2R 274 045
600 x 600	710 x 800 x 80	■	ER 2R 060 060
750 x 600	860 x 800 x 80	■	ER 2R 075 060
900 x 600	1010 x 800 x 80	■	ER 2R 090 060
1220 x 600	1330 x 800 x 80	■ ■	ER 2R 122 060
1370 x 600	1480 x 800 x 80	■ ■	ER 2R 137 060
1520 x 600	1630 x 800 x 80	■ ■	ER 2R 152 060
1670 x 600	1780 x 800 x 80	■ ■	ER 2R 167 060
1820 x 600	1930 x 800 x 80	■ ■	ER 2R 182 060
1840 x 600	1950 x 800 x 80	■ ■ ■	ER 2R 184 060
1990 x 600	2100 x 800 x 80	■ ■ ■	ER 2R 199 060
2140 x 600	2250 x 800 x 80	■ ■ ■	ER 2R 214 060
2290 x 600	2400 x 800 x 80	■ ■ ■	ER 2R 229 060
2440 x 600	2550 x 800 x 80	■ ■ ■	ER 2R 244 060
2590 x 600	2700 x 800 x 80	■ ■ ■	ER 2R 259 060
2740 x 600	2850 x 800 x 80	■ ■ ■	ER 2R 274 060
600 x 750	710 x 950 x 80	■	ER 2R 060 075
750 x 750	860 x 950 x 80	■	ER 2R 075 075
1220 x 750	1330 x 950 x 80	■ ■	ER 2R 122 075
1370 x 750	1480 x 950 x 80	■ ■	ER 2R 137 075
1520 x 750	1630 x 950 x 80	■ ■	ER 2R 152 075
1840 x 750	1950 x 950 x 80	■ ■ ■	ER 2R 184 075
1990 x 750	2100 x 950 x 80	■ ■ ■	ER 2R 199 075
2140 x 750	2250 x 950 x 80	■ ■ ■	ER 2R 214 075
2290 x 750	2400 x 950 x 80	■ ■ ■	ER 2R 229 075
600 x 900	710 x 1100 x 80	■	ER 2R 060 090
750 x 900	860 x 1100 x 80	■	ER 2R 075 090
900 x 900	1010 x 1100 x 80	■	ER 2R 090 090
1220 x 900	1330 x 1100 x 80	■ ■	ER 2R 122 090
1370 x 900	1480 x 1100 x 80	■ ■	ER 2R 137 090
1520 x 900	1630 x 1100 x 80	■ ■	ER 2R 152 090
1670 x 900	1780 x 1100 x 80	■ ■	ER 2R 167 090
1820 x 900	1930 x 1100 x 80	■ ■	ER 2R 182 090
1840 x 900	1950 x 1100 x 80	■ ■ ■	ER 2R 184 090
1990 x 900	2100 x 1100 x 80	■ ■ ■	ER 2R 199 090
2140 x 900	2250 x 1100 x 80	■ ■ ■	ER 2R 214 090
2290 x 900	2400 x 1100 x 80	■ ■ ■	ER 2R 229 090
500 x 1000	680 x 1200 x 80	■	ER 2R 050 100
1020 x 1000	1200 x 1200 x 80	■ ■	ER 2R 102 100
1540 x 1000	1720 x 1200 x 80	■ ■ ■	ER 2R 154 100
2060 x 1000	2240 x 1200 x 80	■ ■ ■	ER 2R 206 100

1/2/3 part covers with solid top anti-slip surface B125

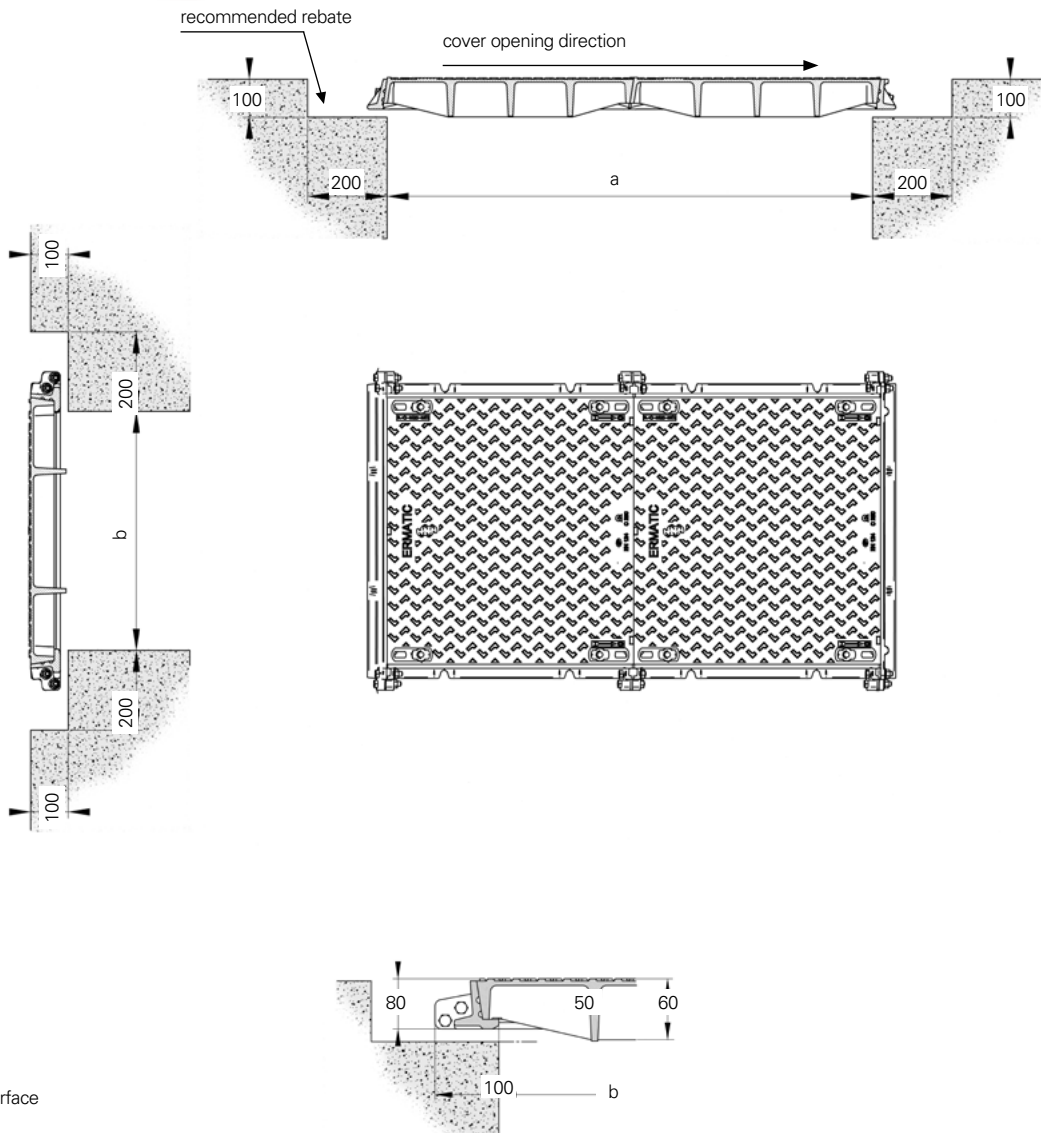

Dimensions in mm
Solid top anti-slip surface

1/2/3 part covers with solid top anti-slip surface B125

Area of installation

Footways, pedestrian areas and comparable areas, car parks or car parking decks.
Group 2 and lower as per EN124.

Specification

- ERMATIC B125 Access Cover and frame
- Solid top cover with anti-slip surface
- Clear opening (a x b) in mm: **reference ER2S** (a x b) in cm
- Machined vertical and horizontal contact faces
- Ductile cast iron according to ISO 1083 and EN 1563
- Quality assurance by third party certification to ISO 9001

Options

- Locking by 4 stainless steel bolts
 - Standard locking (VCHC)
 - Security locking (VOTC)
- Level adjusting bolts (see detail on page10)
- Hinged covers (see detail on page 12)
- Safety grids (see detail on pages 144-145)

Handling

- Pair of EM keys (weight 8 kg per pair) (see detail on p.13)
See handling details in the attached technical file.

Technical file (see pages 87 - 96)

- Installation recommendations
- Rebate preparation
- Installation and shuttering
- Operation of covers
- Maintenance
- Full technical specification

clear opening axb (mm)	overall frame length x width x height (mm)	number of covers	reference
300 x 300	410 x 500 x 80	■	ER2S 030 030
620 x 300	730 x 500 x 80	■ ■	ER2S 062 030
940 x 300	1050 x 500 x 80	■ ■ ■	ER2S 094 030
450 x 450	560 x 650 x 80	■	ER2S 045 045
920 x 450	1030 x 650 x 80	■ ■	ER2S 092 045
1390 x 450	1500 x 650 x 80	■ ■ ■	ER2S 139 045
600 x 600	710 x 800 x 80	■	ER2S 060 060
750 x 600	860 x 800 x 80	■	ER2S 075 060
1220 x 600	1330 x 800 x 80	■ ■	ER2S 122 060
1520 x 600	1630 x 800 x 80	■ ■ ■	ER2S 152 060
1840 x 600	1950 x 800 x 80	■ ■ ■ ■	ER2S 184 060
2290 x 600	2400 x 800 x 80	■ ■ ■ ■	ER2S 229 060
750 x 750	860 x 950 x 80	■	ER2S 075 075
1520 x 750	1630 x 950 x 80	■ ■	ER2S 152 075
2290 x 750	2400 x 950 x 80	■ ■ ■	ER2S 229 075
600 x 900	710 x 1100 x 80	■	ER2S 060 090
750 x 900	860 x 1100 x 80	■	ER2S 075 090
900 x 900	1010 x 1100 x 80	■	ER2S 090 090
1220 x 900	1330 x 1100 x 80	■ ■	ER2S 122 090
1370 x 900	1480 x 1100 x 80	■ ■	ER2S 137 090
1520 x 900	1630 x 1100 x 80	■ ■ ■	ER2S 152 090
1670 x 900	1780 x 1100 x 80	■ ■ ■	ER2S 167 090
1820 x 900	1930 x 1100 x 80	■ ■ ■	ER2S 182 090
1840 x 900	1950 x 1100 x 80	■ ■ ■ ■	ER2S 184 090
1990 x 900	2100 x 1100 x 80	■ ■ ■ ■	ER2S 199 090
2140 x 900	2250 x 1100 x 80	■ ■ ■ ■	ER2S 214 090
2290 x 900	2400 x 1100 x 80	■ ■ ■ ■	ER2S 229 090
2440 x 900	2550 x 1100 x 80	■ ■ ■ ■	ER2S 244 090
2590 x 900	2700 x 1100 x 80	■ ■ ■ ■	ER2S 259 090
2740 x 900	2850 x 1100 x 80	■ ■ ■ ■	ER2S 274 090

Options

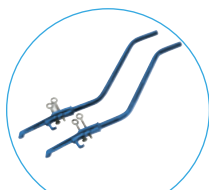

Handling key

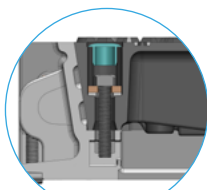

CHC locking

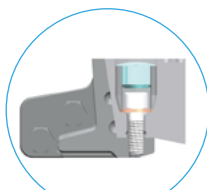

OTC locking

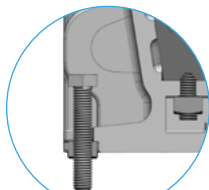

Levelling bolts



Safety grids



Synthetic seal for
corrosive environments

1/2/3 part covers recessed for concrete infill C250

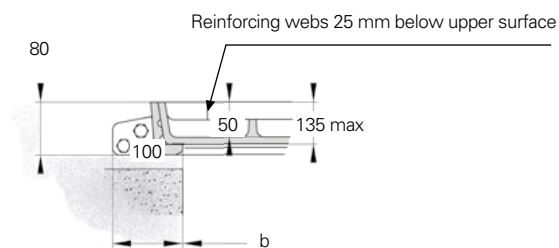
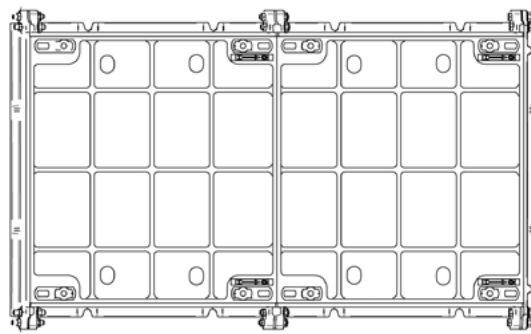
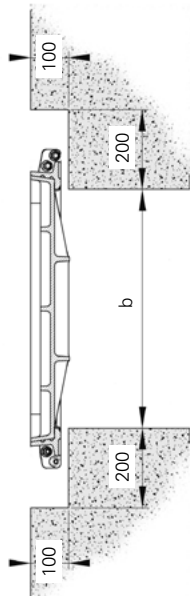
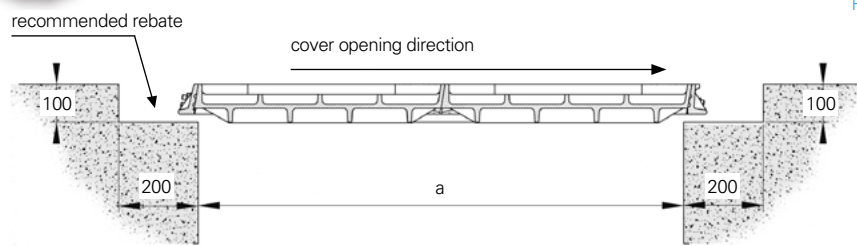

Dimensions in mm
Cover recessed for filling with 40 MPA concrete
See recommendations on p. D8

1/2/3 part covers recessed for concrete infill C250

Area of installation

Parking and yard areas for all types of road vehicles, forecourts and service areas.
Group 3 and lower as per EN124

Specification

- ERMATIC C250 Access Cover and frame
- Cover recessed for concrete infill (or pavior infill if applicable)
- Clear opening (a x b) in mm : **reference ER3R** (a x b) in cm
- Machined vertical and horizontal contact faces
- Ductile cast iron according to ISO 1083 and EN 1563.
- Quality assurance by third party certification to ISO 9001

Options

- Locking by 4 stainless steel bolts
 - Standard locking (VCHC)
 - Security locking (VOTC)
- Level adjusting bolts (see detail on page 10)
- Safety grids (see detail on pages 144-145)

Handling

- Pair of EM keys (weight 8 kg per pair) (see detail on page 13)
See handling details in the attached technical file

Technical file (see pages 87 - 96)

- Installation recommendations
- Rebate preparation
- Installation and shuttering
- Concrete infill
- Operation of covers
- Maintenance
- Full technical specification

Options

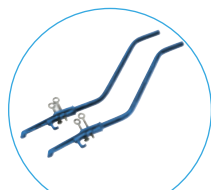

Handling key

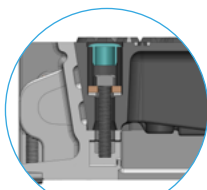

CHC locking

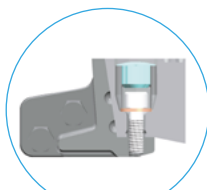

OTC locking

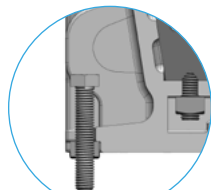

Levelling bolts



Safety grids



Synthetic seal for corrosive environments

clear opening axb (mm)	overall frame dim. length x width x height (mm)	number of covers	reference
750 x 300	860 x 500 x 80	■	ER 3R 075 030
1520 x 300	1630 x 500 x 80	■ ■	ER 3R 152 030
2290 x 300	2400 x 500 x 80	■ ■ ■	ER 3R 229 030
450 x 450	560 x 650 x 80	■	ER 3R 045 045
600 x 450	710 x 650 x 80	■	ER 3R 060 045
900 x 450	1010 x 650 x 80	■	ER 3R 090 045
920 x 450	1030 x 650 x 80	■ ■	ER 3R 092 045
1070 x 450	1180 x 650 x 80	■ ■	ER 3R 107 045
1220 x 450	1330 x 650 x 80	■ ■	ER 3R 122 045
1390 x 450	1500 x 650 x 80	■ ■ ■	ER 3R 139 045
1520 x 450	1630 x 650 x 80	■ ■ ■	ER 3R 152 045
1540 x 450	1650 x 650 x 80	■ ■ ■	ER 3R 154 045
1820 x 450	1930 x 650 x 80	■ ■	ER 3R 182 045
1840 x 450	1950 x 650 x 80	■ ■ ■	ER 3R 184 045
2140 x 450	2250 x 650 x 80	■ ■ ■	ER 3R 214 045
2440 x 450	2550 x 650 x 80	■ ■ ■	ER 3R 244 045
2740 x 450	2850 x 650 x 80	■ ■ ■	ER 3R 274 045
600 x 600	710 x 800 x 80	■	ER 3R 060 060
750 x 600	860 x 800 x 80	■	ER 3R 075 060
900 x 600	1010 x 800 x 80	■	ER 3R 090 060
1220 x 600	1330 x 800 x 80	■ ■	ER 3R 122 060
1370 x 600	1480 x 800 x 80	■ ■	ER 3R 137 060
1520 x 600	1630 x 800 x 80	■ ■	ER 3R 152 060
1670 x 600	1780 x 800 x 80	■ ■	ER 3R 167 060
1820 x 600	1930 x 800 x 80	■ ■	ER 3R 182 060
1840 x 600	1950 x 800 x 80	■ ■ ■	ER 3R 184 060
1990 x 600	2100 x 800 x 80	■ ■ ■	ER 3R 199 060
2140 x 600	2250 x 800 x 80	■ ■ ■	ER 3R 214 060
2290 x 600	2400 x 800 x 80	■ ■ ■	ER 3R 229 060
2440 x 600	2550 x 800 x 80	■ ■ ■	ER 3R 244 060
2590 x 600	2700 x 800 x 80	■ ■ ■	ER 3R 259 060
2740 x 600	2850 x 800 x 80	■ ■ ■	ER 3R 274 060
600 x 750	710 x 950 x 80	■	ER 3R 060 075
750 x 750	860 x 950 x 80	■	ER 3R 075 075
1220 x 750	1330 x 950 x 80	■ ■	ER 3R 122 075
1370 x 750	1480 x 950 x 80	■ ■	ER 3R 137 075
1520 x 750	1630 x 950 x 80	■ ■	ER 3R 152 075
1840 x 750	1950 x 950 x 80	■ ■ ■	ER 3R 184 075
1990 x 750	2100 x 950 x 80	■ ■ ■	ER 3R 199 075
2140 x 750	2250 x 950 x 80	■ ■ ■	ER 3R 214 075
2290 x 750	2400 x 950 x 80	■ ■ ■	ER 3R 229 075
600 x 900	710 x 1100 x 80	■	ER 3R 060 090
750 x 900	860 x 1100 x 80	■	ER 3R 075 090
900 x 900	1010 x 1100 x 80	■	ER 3R 090 090
1220 x 900	1330 x 1100 x 80	■ ■	ER 3R 122 090
1370 x 900	1480 x 1100 x 80	■ ■	ER 3R 137 090
1520 x 900	1630 x 1100 x 80	■ ■	ER 3R 152 090
1670 x 900	1780 x 1100 x 80	■ ■	ER 3R 167 090
1820 x 900	1930 x 1100 x 80	■ ■	ER 3R 182 090
1840 x 900	1950 x 1100 x 80	■ ■ ■	ER 3R 184 090
1990 x 900	2100 x 1100 x 80	■ ■ ■	ER 3R 199 090
2140 x 900	2250 x 1100 x 80	■ ■ ■	ER 3R 214 090
2290 x 900	2400 x 1100 x 80	■ ■ ■	ER 3R 229 090
500 x 1000	680 x 1200 x 80	■	ER 3R 050 100
1020 x 1000	1200 x 1200 x 80	■ ■	ER 3R 102 100
1540 x 1000	1720 x 1200 x 80	■ ■ ■	ER 3R 154 100
2060 x 1000	2240 x 1200 x 80	■ ■ ■	ER 3R 206 100
750 x 1200	930 x 1400 x 80	■	ER 3R 075 120
1520 x 1200	1700 x 1400 x 80	■ ■	ER 3R 152 120
2290 x 1200	2470 x 1400 x 80	■ ■ ■	ER 3R 229 120

recessed for block paving

(allows the insertion of small element paving :max height 100 mm)

600 x 600	710 x 800 x 80	■	ER3P 060 060
1220 x 600	1330 x 800 x 80	■ ■	ER3P 122 060
1840 x 600	1950 x 800 x 80	■ ■ ■	ER3P 184 060

1/2/3 part covers with solid top anti-slip surface C250

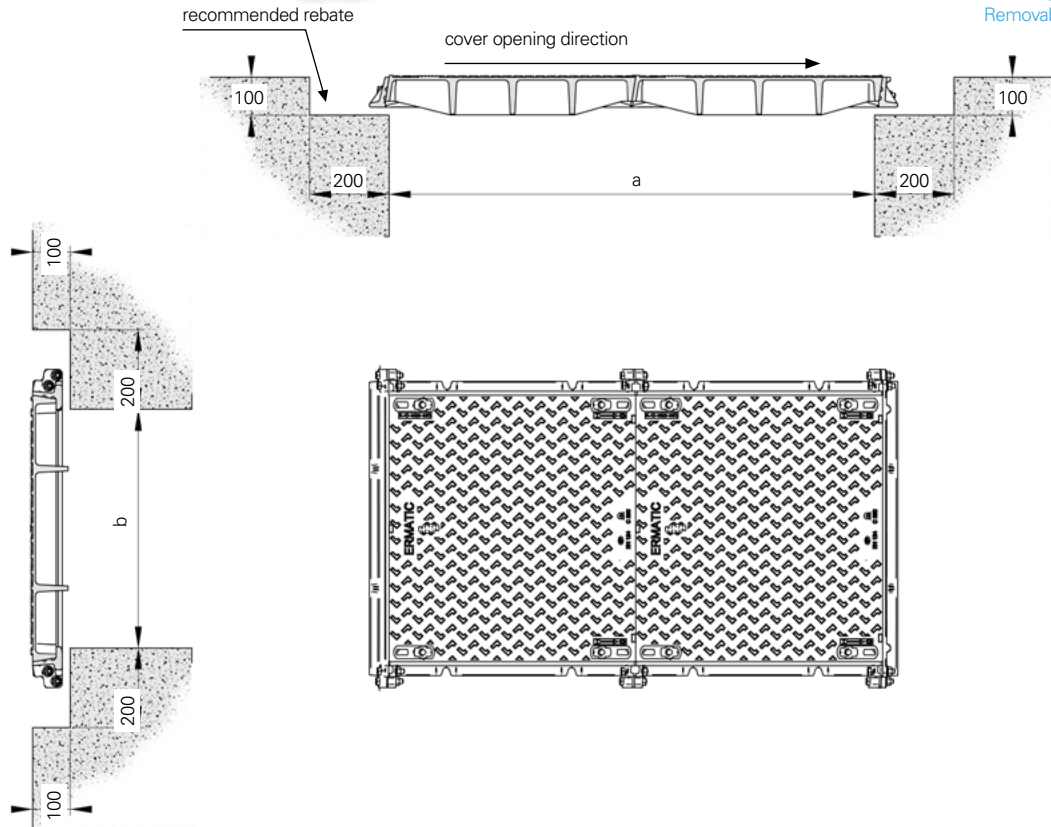

Removable plug cover

Dimensions in mm
Solid top anti-slip surface

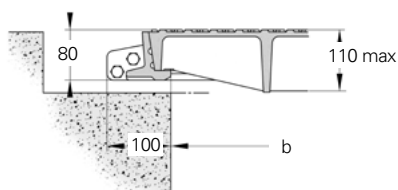

1/2/3 part covers with solid top anti-slip surface C250

Area of installation

Parking and yard areas for all types of road vehicles, forecourts and service areas.
Group 3 and lower as per EN124

Specification

- ERMATIC C250 Access Cover and frame
- Solid top cover with anti-slip surface
- Clear opening (a x b) in mm **reference ER3S** (a x b) in cm
- Machined vertical and horizontal contact faces
- Ductile cast iron according to ISO 1083 and EN 1563
- Quality assurance by third party certification to ISO 9001

Options

- Locking by 4 stainless steel bolts
 - Standard locking (VCHC)
 - Security locking (VOTC)
- Level adjusting bolts (see detail on page 10)
- Hinged covers (see detail on page 12)
- Safety grids (see detail on pages 144-145)

Handling

- Pair of EM keys (weight 8 kg per pair) (see detail on page 13)
See handling details in the attached technical file

Technical file (see pages 87 - 96)

- Installation recommendations
- Rebate preparation
- Installation and shuttering
- Operation of covers
- Maintenance
- Full technical specification

clear opening axb (mm)	overall frame dim. length x width x height (mm)	number of covers	reference
300 x 300	410 x 500 x 80	■	ER3S 030 030
620 x 300	730 x 500 x 80	■ ■	ER3S 062 030
940 x 300	1050 x 500 x 80	■ ■ ■	ER3S 094 030
450 x 450	560 x 650 x 80	■	ER3S 045 045
920 x 450	1030 x 650 x 80	■ ■	ER3S 092 045
1390 x 450	1500 x 650 x 80	■ ■ ■	ER3S 139 045
600 x 600	710 x 800 x 80	■	ER3S 060 060
750 x 600	860 x 860 x 80	■	ER3S 075060
1220 x 600	1330 x 800 x 80	■ ■	ER3S 122 060
1520 x 600	1630 x 800 x 80	■ ■ ■	ER3S 152 060
1840 x 600	1950 x 800 x 80	■ ■ ■ ■	ER3S 184 060
2290 x 600	2400 x 800 x 80	■ ■ ■ ■	ER3S 229 060
750 x 750	860 x 950 x 80	■	ER3S 075 075
1520 x 750	1630 x 950 x 80	■ ■	ER3S 152 075
2290 x 750	2400 x 950 x 80	■ ■ ■	ER3S 229 075
600 x 900	710 x 1100 x 80	■	ER3S 060 090
750 x 900	860 x 1100 x 80	■	ER3S 075 090
900 x 900	1010 x 1100 x 80	■	ER3S 090 090
1220 x 900	1330 x 1100 x 80	■ ■	ER3S 122 090
1370 x 900	1480 x 1100 x 80	■ ■	ER3S 137 090
1520 x 900	1630 x 1100 x 80	■ ■ ■	ER3S 152 090
1670 x 900	1780 x 1100 x 80	■ ■ ■	ER3S 167 090
1820 x 900	1930 x 1100 x 80	■ ■ ■	ER3S 182 090
1840 x 900	1950 x 1100 x 80	■ ■ ■ ■	ER3S 184 090
1990 x 900	2100 x 1100 x 80	■ ■ ■ ■	ER3S 199 090
2140 x 900	2250 x 1100 x 80	■ ■ ■ ■	ER3S 214 090
2290 x 900	2400 x 1100 x 80	■ ■ ■ ■	ER3S 229 090
2440 x 900	2550 x 1100 x 80	■ ■ ■ ■	ER3S 244 090
2590 x 900	2700 x 1100 x 80	■ ■ ■ ■	ER3S 259 090
2740 x 900	2850 x 1100 x 80	■ ■ ■ ■	ER3S 274 090
500 x 1000	610 x 1200 x 80	■	ER3S 050 100
1020 x 1000	1130 x 1200 x 80	■ ■	ER3S 102 100
1540 x 1000	1650 x 1200 x 80	■ ■ ■	ER3S 154 100



Options

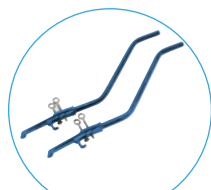

Handling key

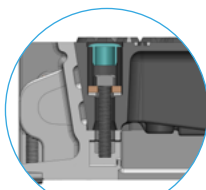

CHC locking

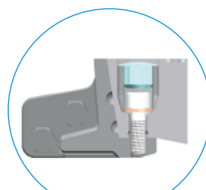

OTC locking

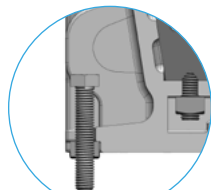

Levelling bolts



Safety grids



Synthetic seal for corrosive environments

Optional: Cover with removable plug

250 mm diameter clear opening positioned centrally in the cover

600 x 600	710 x 800 x 80	□	ER3T 060 060
1220 x 600	1330 x 800 x 80	□ ■	ER3T 122 060
1840 x 600	1950 x 800 x 80	□ ■ ■	ER3T 184 060
900 x 900	1010 x 1100 x 80	□	ER3T 090 090
1820 x 900	1930 x 1100 x 80	□ ■	ER3T 182 090
2740 x 900	2850 x 1100 x 80	■ ■ ■	ER3T 274 090

1 removable plug per unit unless specifically requested

1/2/3 part covers recessed for concrete infill D400

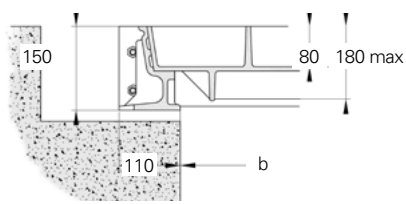
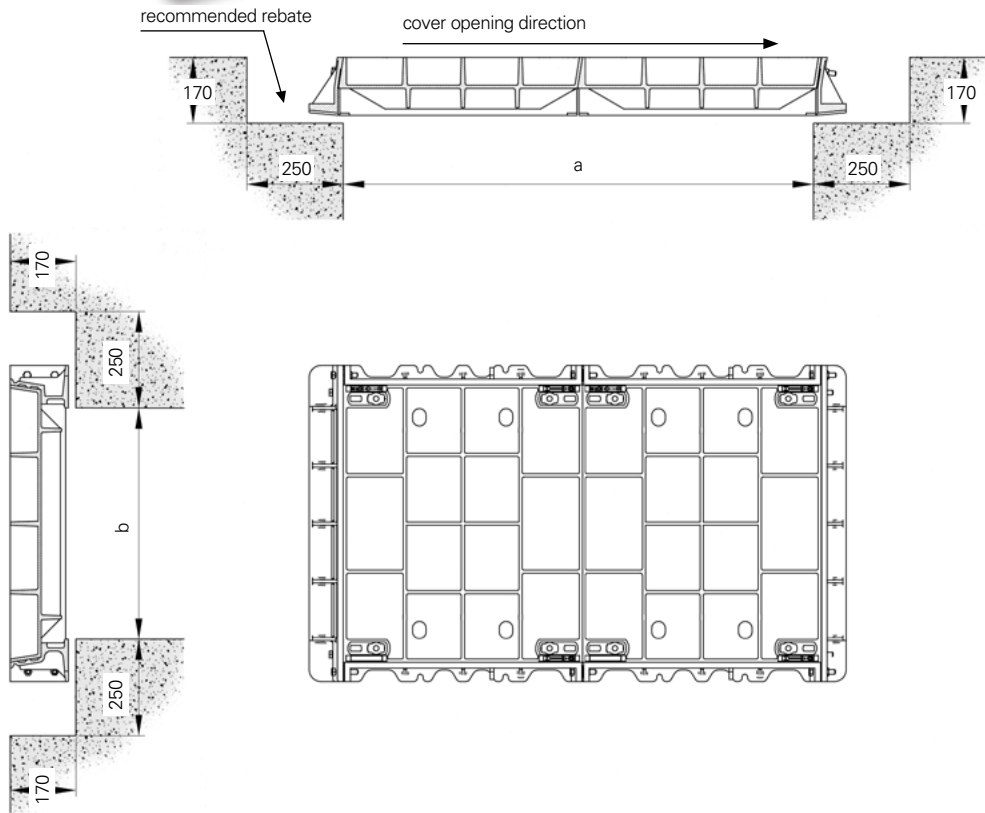

Dimensions in mm
Cover recessed for filling with 40 MPA concrete
See recommendations on p. D8

1/2/3 part covers recessed for concrete infill D400

Area of installation

Carriageways of roads (including pedestrian streets),
hard shoulders and parking areas for all types of road vehicles.
Group 4 and lower as per EN124

Specification

- ERMATIC D400 Access Cover and frame
- Cover recessed for concrete infill
- Clear opening (a x b) in mm:
reference ER5R (a x b) in cm, 150mm deep frame
reference ER4R (a x b) in cm, 125mm deep frame
- Machined vertical and horizontal contact faces
- Ductile cast iron according to ISO 1083 and EN 1563
- Quality assurance by third party, certification to ISO 9001

Locking

- By 4 stainless steel bolts
- Standard locking (VCHC)

Options

- Security locking (VOTC)
- Level adjusting bolts (see detail on page 10)
- Safety grids (see detail on pages 144-145)

Handling

- Pair of EM keys (weight 8 kg per pair) (see detail on page 13)
- See handling details in the attached technical file.

Technical file (see pages 87 - 96)

- Installation recommendations
- Rebate preparation
- Installation and shuttering
- Concrete infill
- Operation of covers
- Maintenance
- Full technical specification

clear opening axb (mm)	overall frame dim. length x width x height (mm)	number of covers	reference
600 x 600	770 x 820 x 150	■	ER5R 060 060 VCHC
750 x 600	920 x 820 x 150	■	ER5R 075 060 VCHC
1220 x 600	1390 x 820 x 150	■ ■	ER5R 122 060 VCHC
1370 x 600	1540 x 820 x 150	■ ■	ER5R 137 060 VCHC
1520 x 600	1690 x 820 x 150	■ ■	ER5R 152 060 VCHC
1840 x 600	2010 x 820 x 150	■ ■ ■	ER5R 184 060 VCHC
1990 x 600	2160 x 820 x 150	■ ■ ■	ER5R 199 060 VCHC
2140 x 600	2310 x 820 x 150	■ ■ ■	ER5R 214 060 VCHC
2290 x 600	2460 x 820 x 150	■ ■ ■	ER5R 229 060 VCHC
600 x 750	770 x 970 x 150	■	ER5R 060 075 VCHC
750 x 750*	920 x 970 x 125	■	ER4R 075 075 VCHC
1220 x 750	1390 x 970 x 150	■ ■	ER5R 122 075 VCHC
1370 x 750	1540 x 970 x 150	■ ■	ER5R 137 075 VCHC
1520 x 750*	1690 x 970 x 125	■ ■	ER4R 152 075 VCHC
1840 x 750	2010 x 970 x 150	■ ■ ■	ER5R 184 075 VCHC
1990 x 750	2160 x 970 x 150	■ ■ ■	ER5R 199 075 VCHC
2140 x 750	2310 x 970 x 150	■ ■ ■	ER5R 214 075 VCHC
2290 x 750*	2460 x 970 x 125	■ ■ ■	ER4R 229 075 VCHC
800 x 800*	970 x 980 x 125	■	ER4R 080 080 VCHC
1620 x 800*	1790 x 980 x 125	■ ■	ER4R 162 080 VCHC
2440 x 800*	2610 x 980 x 125	■ ■ ■	ER4R 244 080 VCHC
600 x 900	770 x 1120 x 150	■	ER5R 060 090 VCHC
750 x 900	920 x 1120 x 150	■	ER5R 075 090 VCHC
900 X 900*	1070 x 1080 x 125	■	ER4R 090 090 VCHC
1220 x 900	1390 x 1120 x 150	■ ■	ER5R 122 090 VCHC
1370 x 900	1540 x 1120 x 150	■ ■	ER5R 137 090 VCHC
1520 x 900	1690 x 1120 x 150	■ ■	ER5R 152 090 VCHC
1820 X 900*	1990 x 1080 x 125	■ ■	ER4R 182 090 VCHC
1840 x 900	2010 x 1120 x 150	■ ■ ■	ER5R 184 090 VCHC
1990 x 900	2160 x 1120 x 150	■ ■ ■	ER5R 199 090 VCHC
2140 x 900	2310 x 1120 x 150	■ ■ ■	ER5R 214 090 VCHC
2290 x 900	2460 x 1120 x 150	■ ■ ■	ER5R 229 090 VCHC
2740 X 900*	2910 x 1080 x 125	■ ■ ■	ER4R 274 090 VCHC
500 x 1000	670 x 1220 x 150	■	ER5R 050 100 VCHC
1020 x 1000	1190 x 1220 x 150	■ ■	ER5R 102 100 VCHC
1540 x 1000	1710 x 1220 x 150	■ ■ ■	ER5R 154 100 VCHC
2060 x 1000	2230 x 1220 x 150	■ ■ ■	ER5R 206 100 VCHC
750 x 1200*	950 x 1380 x 125	■	ER4R 075 120 VCHC
1520 x 1200*	1720 x 1380 x 125	■ ■	ER4R 152 120 VCHC
2290 x 1200*	2490 x 1380 x 125	■ ■ ■	ER4R 229 120 VCHC

*** Note:**

- ER5R reference: 150mm deep frame
- ER4R reference: 125mm deep frame

Options

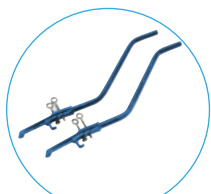

Handling key

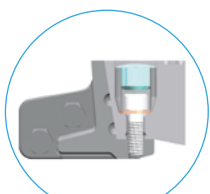

OTC locking

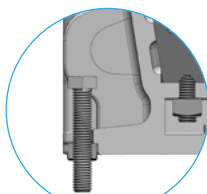

Levelling bolts



Safety grids



Synthetic seal for
corrosive environments

1/2/3 part covers with solid top anti-slip surface D400

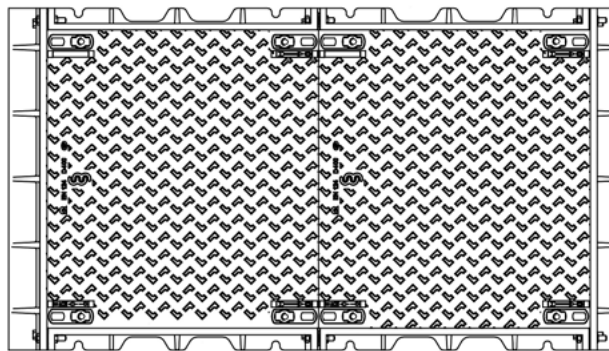
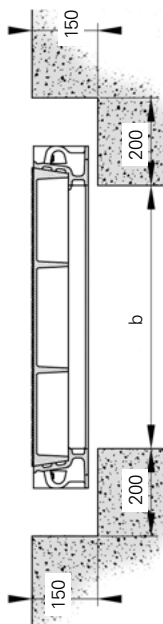
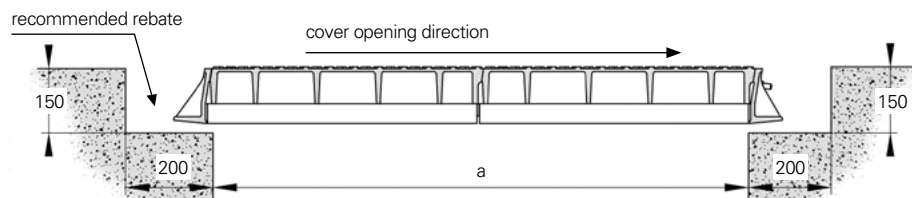

Dimensions in mm
Solid top anti-slip surface

1/2/3 part covers with solid top anti-slip surface D400

Area of installation

Carriageways of roads (including pedestrian streets),
hard shoulders and parking areas for all types of road vehicles.
Group 4 and lower as per EN124

Specification

- ERMATIC D400 Access Cover and frame
- Solid top covers with anti-slip surface
- Clear opening (a x b) in mm : **reference ER4S** (a x b) in cm
- Machined vertical and horizontal contact faces
- Ductile cast iron according to ISO 1083 and EN 1563
- Quality assurance by third party, certification to ISO 9001

Locking

- By 4 stainless steel bolts
- Standard locking (VCHC)

Options

- Security locking (VOTC)
- Level adjusting bolts (see detail on page 10)
- Hinged and assisted opening by strut (see detail page 12)
- Safety grids (see detail on pages 144-145)

clear opening axb (mm)	overall frame dim. length x width x height (mm)	number of covers	reference
450 x 450	620 x 630 x 125	■	ER4S 045 045 VCHC
920 x 450	1090 x 630 x 125	■■	ER4S 092 045 VCHC
1390 x 450	1560 x 630 x 125	■■■	ER4S 139 045 VCHC
600 x 600	770 x 780 x 125	■	ER4S 060 060 VCHC
1220 x 600	1390 x 780 x 125	■■	ER4S 122 060 VCHC
1940 x 600	2010 x 780 x 125	■■■	ER4S 184 060 VCHC
750 x 750	920 x 930 x 125	■	ER4S 075 075 VCHC
1520 x 750	1690 x 930 x 125	■■	ER4S 152 075 VCHC
2290 x 750	2460 x 930 x 125	■■■	ER4S 229 075 VCHC
800 x 800	970 x 980 x 125	■	ER4S 080 080 VCHC
1620 x 800	1790 x 980 x 125	■■	ER4S 162 080 VCHC
2440 x 800	2610 x 980 x 125	■■■	ER4S 244 080 VCHC
600 x 900	770 x 980 x 125	■	ER4S 060 090 VCHC
900 x 900	1070 x 980 x 125	■	ER4S 090 090 VCHC
1220 x 900	1390 x 980 x 125	■■	ER4S 122 090 VCHC
1520 x 900	1690 x 980 x 125	■■	ER4S 152 090 VCHC
1820 x 900	1990 x 980 x 125	■■	ER4S 182 090 VCHC
1840 x 900	2010 x 980 x 125	■■■	ER4S 184 090 VCHC
2140 x 900	2310 x 980 x 125	■■■	ER4S 214 090 VCHC
2440 x 900	2610 x 980 x 125	■■■	ER4S 244 090 VCHC
2740 x 900	2910 x 980 x 125	■■■	ER4S 274 090 VCHC
1000 x 1000	1170 x 1180 x 125	■	ER4S 100 100 VCHC
2020 x 1000	2190 x 1180 x 125	■■	ER4S 202 100 VCHC
3040 x 1000	3210 x 1180 x 125	■■■	ER4S 304 100 VCHC

Handling

- Pair of EM keys (weight 8 kg per pair) (see detail on page 13)
- See handling details in the attached technical file.

Technical file (see pages 87 - 96)

- Installation recommendations
- Rebate preparation
- Installation and shuttering
- Operation of covers
- Maintenance
- Full technical specification

Options

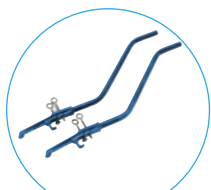

Handling key

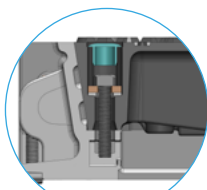

CHC locking

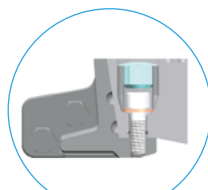

OTC locking

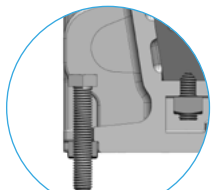

Levelling bolts



Safety grids



Synthetic seal for
corrosive environments

1/2/3 part covers recessed for concrete infill E600

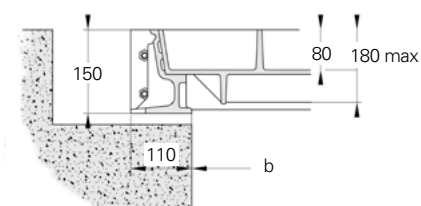
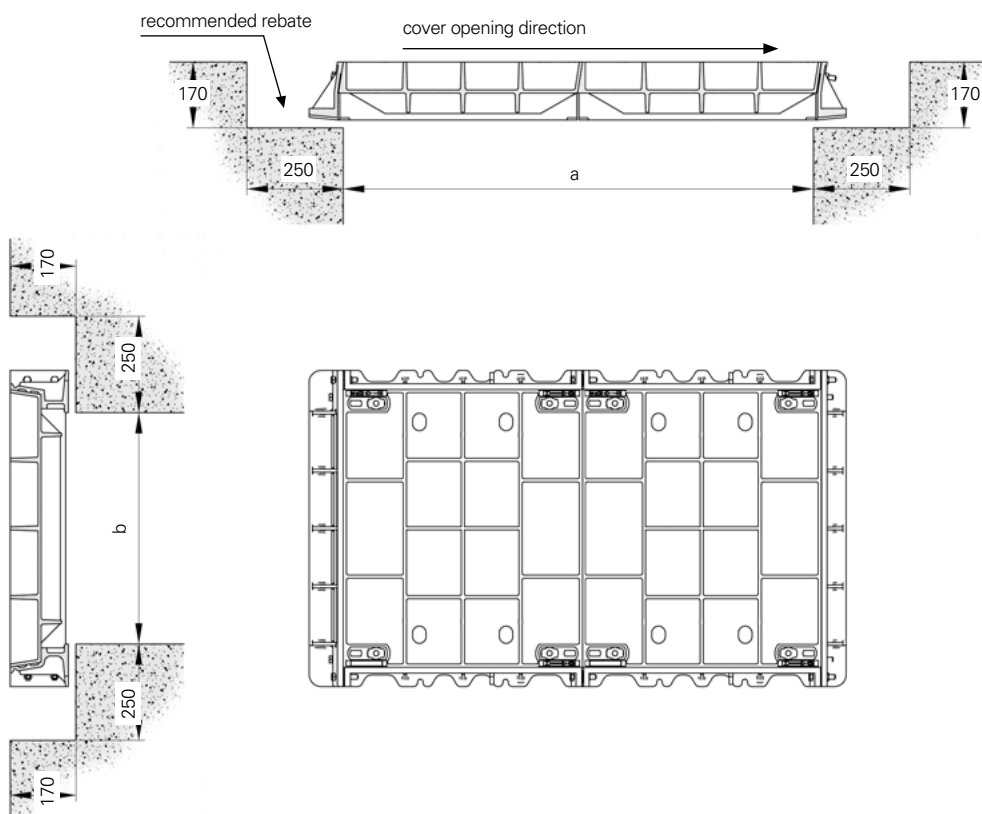

Dimensions in mm
Cover recessed for filling with 40 MPA concrete
See recommendations on p. D8

1/2/3 part covers recessed for concrete infill E600

Area of installation

Areas imposing high wheel loads e.g. docks, aircraft pavements.
Group 5 and lower as per EN124

Specification

- ERMATIC E600 access cover and frame
- Cover recessed for concrete infill
- Clear opening (a x b) in mm: **reference ER6R** (a x b) in cm
- Machined vertical and horizontal contact faces
- Ductile cast iron according to ISO 1083 and EN 1563
- Quality assurance by third party certification to ISO 9001

Options

- Recommended: locking by 4 stainless steel bolts
 - Standard locking (VCHC)
 - Security locking (VOTC)
- Level adjusting bolts (see detail on page 10)
- Safety grids (see detail on pages 144-145)

Handling

- Pair of EM keys (weight 8 kg per pair) (see detail on page 13)
See handling details in the attached technical file.

Technical file (see pages 87 - 96)

- Installation recommendations
- Rebate preparation
- Installation and shuttering
- Concrete infill
- Operation of covers
- Maintenance
- Full technical specification

clear opening axb (mm)	overall frame dim. length x width x height (mm)	number of covers	reference
600 x 600	770 x 820 x 150	■	ER6R 060 060
750 x 600	920 x 820 x 150	■	ER6R 075 060
1220 x 600	1390 x 820 x 150	■ ■	ER6R 122 060
1370 x 600	1540 x 820 x 150	■ ■	ER6R 137 060
1520 x 600	1690 x 820 x 150	■ ■	ER6R 152 060
1840 x 600	2010 x 820 x 150	■ ■ ■ ■	ER6R 184 060
1990 x 600	2160 x 820 x 150	■ ■ ■ ■	ER6R 199 060
2140 x 600	2310 x 820 x 150	■ ■ ■ ■	ER6R 214 060
2290 x 600	2460 x 820 x 150	■ ■ ■ ■	ER6R 229 060
600 x 750	770 x 970 x 150	■	ER6R 060 075
750 x 750*	920 x 970 x 150	■	ER6R 075 075
1220 x 750	1390 x 970 x 150	■ ■	ER6R 122 075
1370 x 750	1540 x 970 x 150	■ ■	ER6R 137 075
1520 x 750*	1690 x 970 x 150	■ ■	ER6R 152 075
1840 x 750	2010 x 970 x 150	■ ■ ■ ■	ER6R 184 075
1990 x 750	2160 x 970 x 150	■ ■ ■ ■	ER6R 199 075
2140 x 750	2310 x 970 x 150	■ ■ ■ ■	ER6R 214 075
2290 x 750*	2460 x 970 x 150	■ ■ ■ ■	ER6R 229 075
600 x 900	770 x 1120 x 150	■	ER6R 060 090
750 x 900	920 x 1120 x 150	■	ER6R 075 090
1220 x 900	1390 x 1120 x 150	■ ■	ER6R 122 090
1370 x 900	1540 x 1120 x 150	■ ■	ER6R 137 090
1520 x 900	1690 x 1120 x 150	■ ■	ER6R 152 090
1840 x 900	2010 x 1120 x 150	■ ■ ■ ■	ER6R 184 090
1990 x 900	2160 x 1120 x 150	■ ■ ■ ■	ER6R 199 090
2140 x 900	2310 x 1120 x 150	■ ■ ■ ■	ER6R 214 090
2290 x 900	2460 x 1120 x 150	■ ■ ■ ■	ER6R 229 090
500 x 1000	670 x 1220 x 150	■	ER6R 050 100
1020 x 1000	1190 x 1220 x 150	■ ■	ER6R 102 100
1540 x 1000	1710 x 1220 x 150	■ ■ ■ ■	ER6R 154 100
2060 x 1000	2230 x 1220 x 150	■ ■ ■ ■ ■ ■	ER6R 206 100
750 x 1200	950 x 1380 x 150	■	ER6R 075 120
1520 x 1200	1720 x 1380 x 150	■ ■	ER6R 152 120
2290 x 1200	2490 x 1380 x 150	■ ■ ■ ■	ER6R 229 120

Options

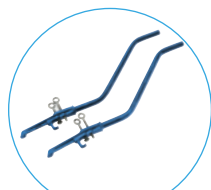

Handling key

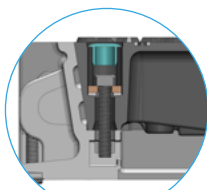

CHC locking

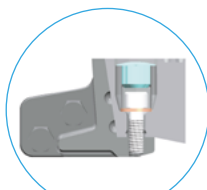

OTC locking

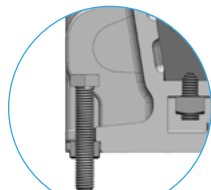

Levelling bolts



Safety grids



Synthetic seal for
corrosive environments

1/2/3 part covers with solid top anti-slip surface E600

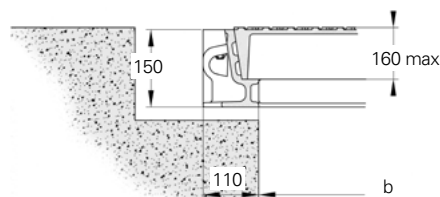
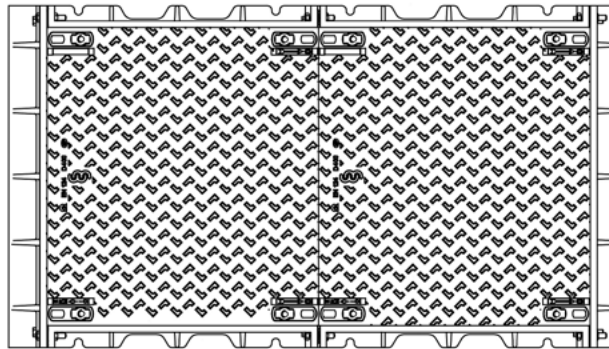
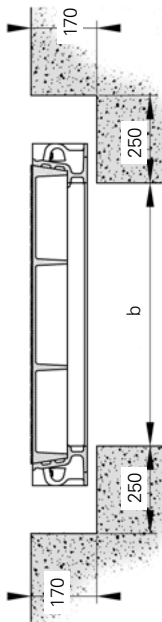
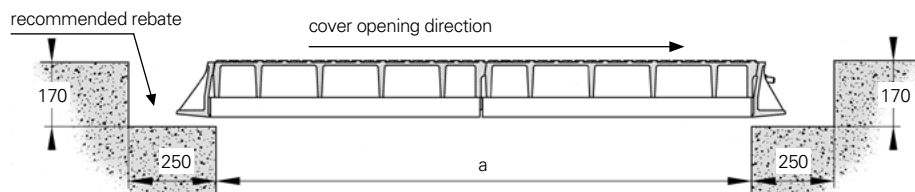

Dimensions in mm
Solid top anti-slip surface

1/2/3 part covers with solid top anti-slip surface E600

Area of installation

Areas imposing high wheel loads e.g. docks, aircraft pavements.
Group 5 and lower as per EN124

Specification

- ERMATIC E600 Access Cover and frame
- Solid top cover with anti-slip surface
- Clear opening (a x b) in mm: **reference ER6S** (a x b) in cm
- Machined vertical and horizontal contact faces
- Ductile cast iron according to ISO 1083 and EN 1563
- Quality assurance by third party certification to ISO 9001

Options

- Recommended: locking by 4 stainless steel bolts
 - Standard locking (VCHC)
 - Security locking (VOTC)
- Level adjusting bolts (see detail on page 10)
- Hinged and assisted opening by strut (see details on page 12)
- Safety grids (see detail on pages 144-145)

Handling

- Pair of EM keys (weight 8 kg per pair) (see detail on page 13)
See handling details in the attached technical file.

Technical file (see pages 87 - 96)

- Installation recommendations
- Rebate preparation
- Installation and shuttering
- Operation of covers
- Maintenance
- Full technical specification

clear opening axb (mm)	overall frame dim. length x width x height (mm)	number of covers	reference
600 x 600	770 x 820 x 150	■	ER6S 060 060
750 x 600	920 x 820 x 150	■	ER6S 075 060
1220 x 600	1390 x 820 x 150	■ ■	ER6S 122 060
1370 x 600	1540 x 820 x 150	■ ■	ER6S 137 060
1520 x 600	1690 x 820 x 150	■ ■	ER6S 152 060
1840 x 600	2010 x 820 x 150	■ ■ ■	ER6S 184 060
1990 x 600	2160 x 820 x 150	■ ■ ■	ER6S 199 060
2140 x 600	2310 x 820 x 150	■ ■ ■	ER6S 214 060
2290 x 600	2460 x 820 x 150	■ ■ ■	ER6S 229 060
600 x 750	770 x 970 x 150	■	ER6S 060 075
750 x 750	920 x 970 x 150	■	ER6S 075 075
1220 x 750	1390 x 970 x 150	■ ■	ER6S 122 075
1370 x 750	1540 x 970 x 150	■ ■	ER6S 137 075
1520 x 750	1690 x 970 x 150	■ ■	ER6S 152 075
1840 x 750	2010 x 970 x 150	■ ■ ■	ER6S 184 075
1990 x 750	2160 x 970 x 150	■ ■ ■	ER6S 199 075
2140 x 750	2310 x 970 x 150	■ ■ ■	ER6S 214 075
2290 x 750	2460 x 970 x 150	■ ■ ■	ER6S 229 075
600 x 900	770 x 1120 x 150	■	ER6S 060 090
750 x 900	920 x 1120 x 150	■	ER6S 075 090
900 x 900	1070 x 1120 x 150	■	ER6S 090 090
1220 x 900	1390 x 1120 x 150	■ ■	ER6S 122 090
1370 x 900	1540 x 1120 x 150	■ ■	ER6S 137 090
1520 x 900	1690 x 1120 x 150	■ ■	ER6S 152 090
1670 x 900	1840 x 1120 x 150	■ ■	ER6S 167 090
1820 x 900	1990 x 1120 x 150	■ ■	ER6S 182 090
1840 x 900	2010 x 1120 x 150	■ ■ ■	ER6S 184 090
1990 x 900	2160 x 1120 x 150	■ ■ ■	ER6S 199 090
2140 x 900	2310 x 1120 x 150	■ ■ ■	ER6S 214 090
2290 x 900	2460 x 1120 x 150	■ ■ ■	ER6S 229 090
2440 x 900	2610 x 1120 x 150	■ ■ ■	ER6S 244 090
2590 x 900	2760 x 1120 x 150	■ ■ ■	ER6S 259 090
2740 x 900	2910 x 1120 x 150	■ ■ ■	ER6S 274 090

Options

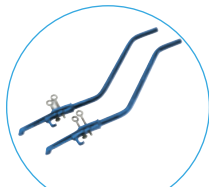

Handling key

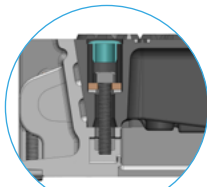

CHC locking

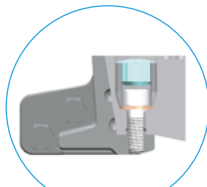

OTC locking

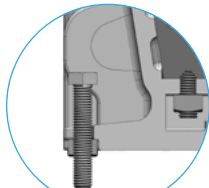

Levelling bolts



Safety grids



Synthetic seal for
corrosive environments

1/2/3 part covers recessed for concrete infill F900

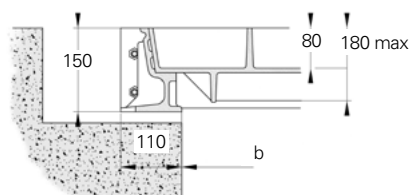
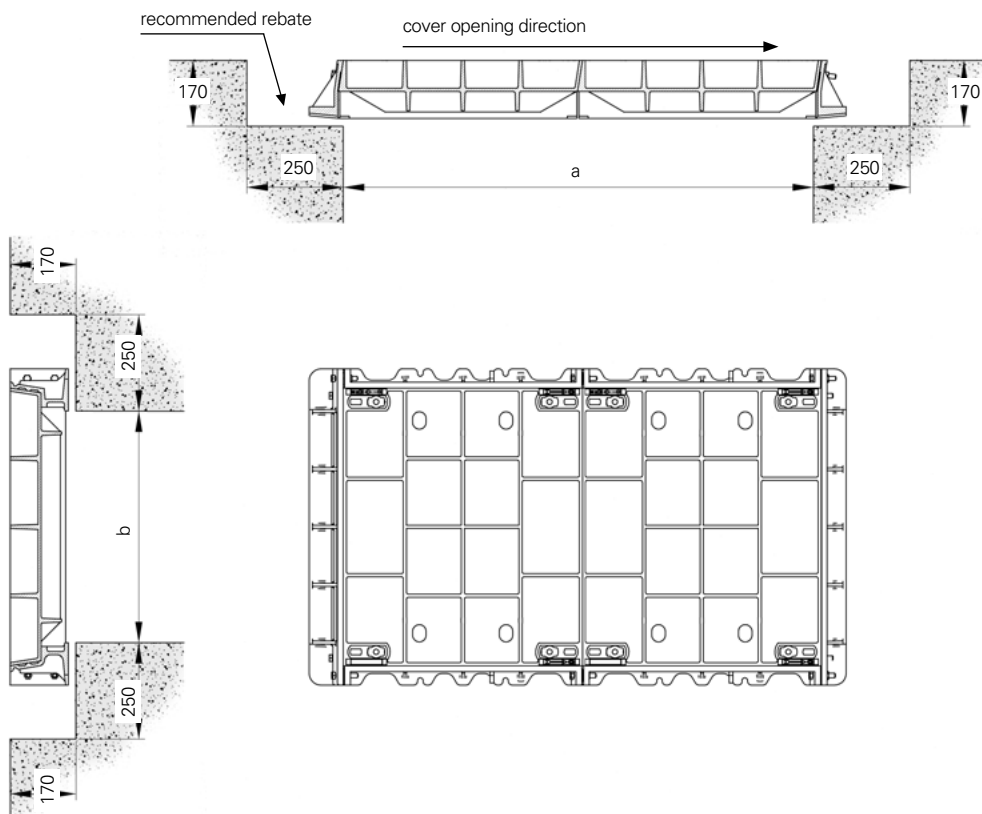
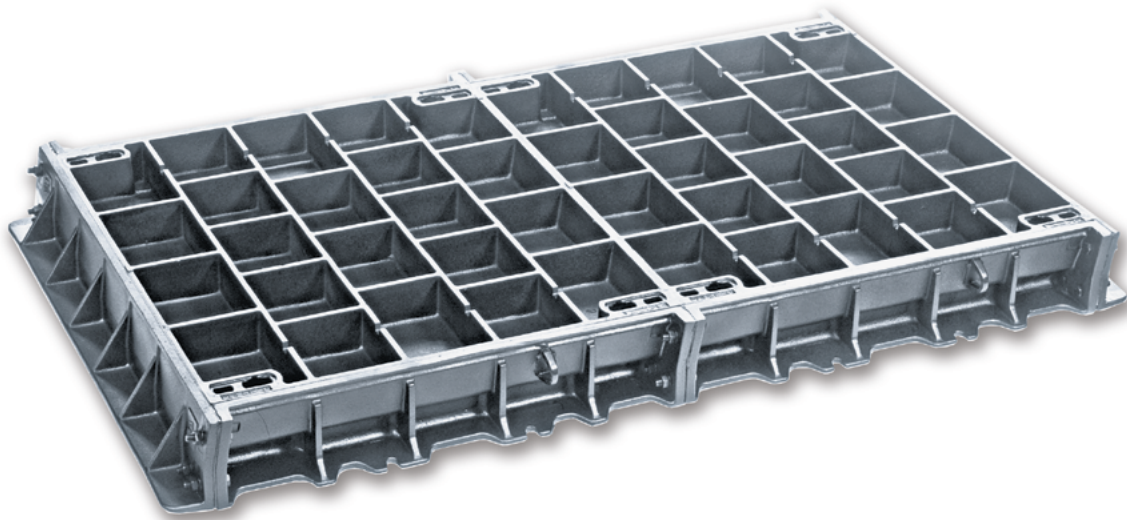

Dimensions in mm
Cover recessed for filling with 40 MPA concrete
See recommendations on p. D8

1/2/3 part covers recessed for concrete infill F900

Area of installation

Areas imposing particularly high wheel loads e.g. docks, aircraft pavements. Group 6 and lower as per EN124

Specification

- ERMATIC F900 access cover and frame
- Cover recessed for concrete infill
- Clear opening (a x b) in mm: **reference ER9R** (a x b) in cm
- Machined vertical and horizontal contact faces
- Ductile cast iron according to ISO 1083 and EN 1563
- Quality assurance by third party certification to ISO 9001

Option

- Recommended: locking by 4 stainless steel bolts
 - Standard locking (VCHC)
 - Security locking (VOTC)
- Level adjusting bolts (see detail on page 10)
- Safety grids (see detail on pages 144-145)

Handling

- Pair of EM keys (weight 8 kg per pair) (see detail on page 13)
- See handling details in the attached technical file.

Technical file (see pages 87 - 96)

- Installation recommendations
- Rebate preparation
- Installation and shuttering
- Concrete infill
- Operation of covers
- Maintenance
- Full technical specification

clear opening axb (mm)	overall frame dim. length x width x height (mm)	number of covers	reference
600 x 600	770 x 820 x 150	■	ER9R 060 060
750 x 600	920 x 820 x 150	■	ER9R 075 060
1220 x 600	1390 x 820 x 150	■ ■	ER9R 122 060
1370 x 600	1540 x 820 x 150	■ ■	ER9R 137 060
1520 x 600	1690 x 820 x 150	■ ■	ER9R 152 060
1840 x 600	2010 x 820 x 150	■ ■ ■	ER9R 184 060
1990 x 600	2160 x 820 x 150	■ ■ ■	ER9R 199 060
2140 x 600	2310 x 820 x 150	■ ■ ■	ER9R 214 060
2290 x 600	2460 x 820 x 150	■ ■ ■	ER9R 229 060
600 x 750	770 x 970 x 150	■	ER9R 060 075
750 x 750	920 x 970 x 150	■	ER9R 075 075
1220 x 750	1390 x 970 x 150	■ ■	ER9R 122 075
1370 x 750	1540 x 970 x 150	■ ■	ER9R 137 075
1520 x 750	1690 x 970 x 150	■ ■	ER9R 152 075
1840 x 750	2010 x 970 x 150	■ ■ ■	ER9R 184 075
1990 x 750	2160 x 970 x 150	■ ■ ■	ER9R 199 075
2140 x 750	2310 x 970 x 150	■ ■ ■	ER9R 214 075
2290 x 750	2460 x 970 x 150	■ ■ ■	ER9R 229 075
600 x 900	770 x 1120 x 150	■	ER9R 060 090
750 x 900	920 x 1120 x 150	■	ER9R 075 090
1220 x 900	1390 x 1120 x 150	■ ■	ER9R 122 090
1370 x 900	1540 x 1120 x 150	■ ■	ER9R 137 090
1520 x 900	1690 x 1120 x 150	■ ■	ER9R 152 090
1840 x 900	2010 x 1120 x 150	■ ■ ■	ER9R 184 090
1990 x 900	2160 x 1120 x 150	■ ■ ■	ER9R 199 090
2140 x 900	2310 x 1120 x 150	■ ■ ■	ER9R 214 090
2290 x 900	2460 x 1120 x 150	■ ■ ■	ER9R 229 090
500 x 1000	670 x 1220 x 150	■	ER9R 050 100
1020 x 1000	1190 x 1220 x 150	■ ■	ER9R 102 100
1540 x 1000	1710 x 1220 x 150	■ ■ ■	ER9R 154 100
2060 x 1000	2230 x 1220 x 150	■ ■ ■ ■	ER9R 206 100
750 x 1200	950 x 1380 x 150	■	ER9R 075 120
1520 x 1200	1720 x 1380 x 150	■ ■	ER9R 152 120
2290 x 1200	2490 x 1380 x 150	■ ■ ■	ER9R 229 120

Options

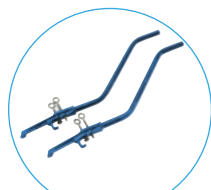

Handling key

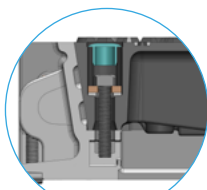

CHC locking

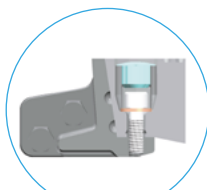

OTC locking

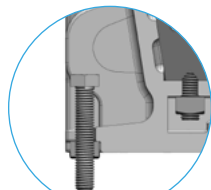

Levelling bolts



Safety grids



Synthetic seal for
corrosive environments

1/2/3 part covers with solid top anti-slip surface F900

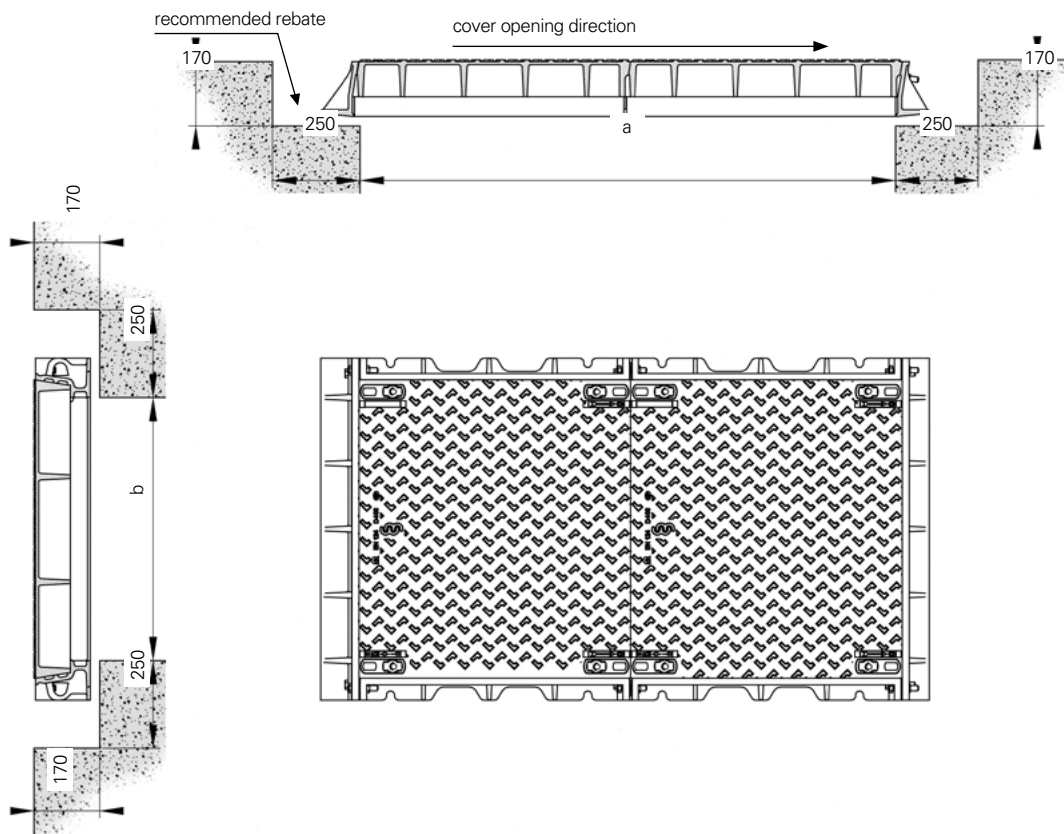
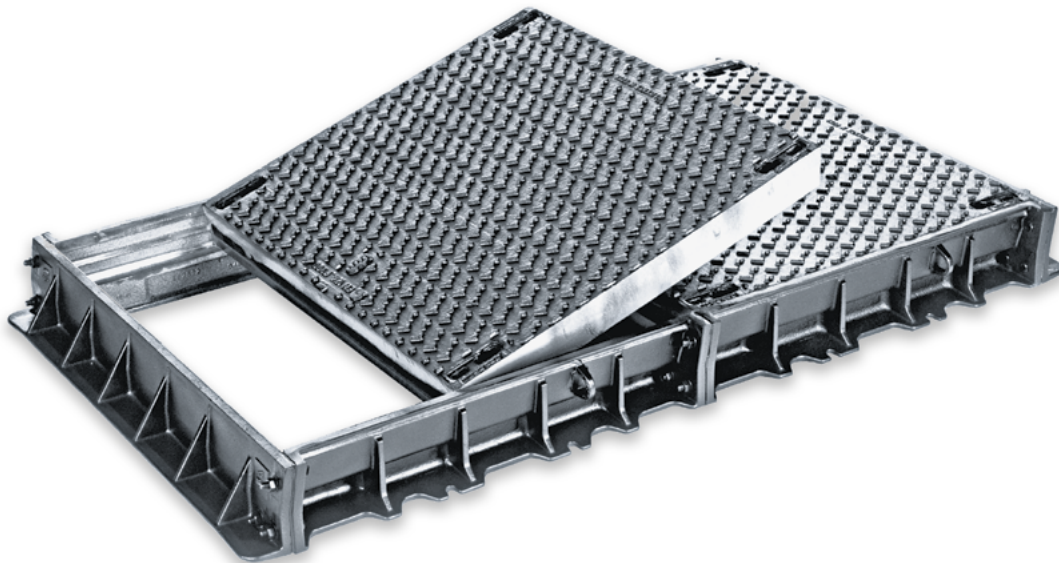

Dimensions in mm
Solid top anti-slip surface



1/2/3 part covers with solid top anti-slip surface F900

Area of installation

Areas imposing particularly high wheel loads e.g. docks, aircraft pavements. Group 6 and lower as per EN124

Specification

- ERMATIC F900 access cover and frame
- Solid top cover with anti-slip surface
- Clear opening (a x b) in mm: **reference ER9S** (a x b) in cm
- Machined vertical and horizontal contact faces
- Ductile cast iron according to ISO 1083 and EN 1563
- Quality assurance by third party certification to ISO 9001

Option

- Recommended: locking by 4 stainless steel bolts
 - Standard locking (VCHC)
 - Security locking (VOTC)
- Level adjusting bolts (see detail on page 10)
- Hinged and assisted opening by strut (see detail on page 12)
- Safety grids (see detail on pages 144-145)

Handling

- Pair of EM keys (weight 8 kg per pair) (see detail on page 13)
See handling details in the attached technical file.

Technical file (see pages 87 - 96)

- Installation recommendations
- Rebate preparation
- Installation and shuttering
- Operation of covers
- Maintenance
- Full technical specification

clear opening axb (mm)	overall frame dim. length x width x height (mm)	number of covers	reference
600 x 600	770 x 820 x 150	■	ER9S 060 060
750 x 600	920 x 820 x 150	■	ER9S 075 060
1220 x 600	1390 x 820 x 150	■ ■	ER9S 122 060
1370 x 600	1540 x 820 x 150	■ ■	ER9S 137 060
1520 x 600	1690 x 820 x 150	■ ■	ER9S 152 060
1840 x 600	2010 x 820 x 150	■ ■ ■	ER9S 184 060
1990 x 600	2160 x 820 x 150	■ ■ ■	ER9S 199 060
2140 x 600	2310 x 820 x 150	■ ■ ■	ER9S 214 060
2290 x 600	2460 x 820 x 150	■ ■ ■	ER9S 229 060
600 x 750	770 x 970 x 150	■	ER9S 060 075
750 x 750	920 x 970 x 150	■	ER9S 075 075
1220 x 750	1390 x 970 x 150	■ ■	ER9S 122 075
1370 x 750	1540 x 970 x 150	■ ■	ER9S 137 075
1520 x 750	1690 x 970 x 150	■ ■	ER9S 152 075
1840 x 750	2010 x 970 x 150	■ ■ ■	ER9S 184 075
1990 x 750	2160 x 970 x 150	■ ■ ■	ER9S 199 075
2140 x 750	2310 x 970 x 150	■ ■ ■	ER9S 214 075
2290 x 750	2460 x 970 x 150	■ ■ ■	ER9S 229 075
600 x 900	770 x 1120 x 150	■	ER9S 060 090
750 x 900	920 x 1120 x 150	■	ER9S 075 090
900 x 900	1070 x 1120 x 150	■	ER9S 090 090
1220 x 900	1390 x 1120 x 150	■ ■	ER9S 122 090
1370 x 900	1540 x 1120 x 150	■ ■	ER9S 137 090
1520 x 900	1690 x 1120 x 150	■ ■	ER9S 152 090
1670 x 900	1840 x 1120 x 150	■ ■	ER9S 167 090
1820 x 900	1990 x 1120 x 150	■ ■	ER9S 182 090
1840 x 900	2010 x 1120 x 150	■ ■ ■	ER9S 184 090
1990 x 900	2160 x 1120 x 150	■ ■ ■	ER6S 199 090
2140 x 900	2310 x 1120 x 150	■ ■ ■	ER9S 214 090
2290 x 900	2460 x 1120 x 150	■ ■ ■	ER9S 229 090
2440 x 900	2610 x 1120 x 150	■ ■ ■	ER9S 244 090
2590 x 900	2760 x 1120 x 150	■ ■ ■	ER9S 259 090
2740 x 900	2910 x 1120 x 150	■ ■ ■	ER9S 274 090



Unit with hinged fire hydrant cover

750 x 750	920 x 970 x 150	■	ER9T 075 075
1520 x 750	1690 x 970 x 150	■ ■	ER9T 152 075
2290 x 750	2460 x 970 x 150	■ ■ ■	ER9T 229 075

The removable plug dimensions are 380 x 230mm

One removable plug per unit, unless specifically requested

Options

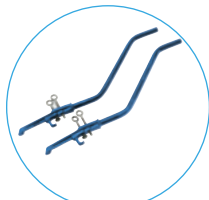

Handling key



CHC locking



OTC locking

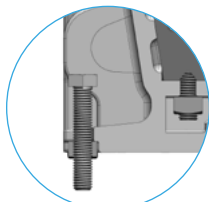

Levelling bolts



Safety grids



Synthetic seal for corrosive environments

Notes

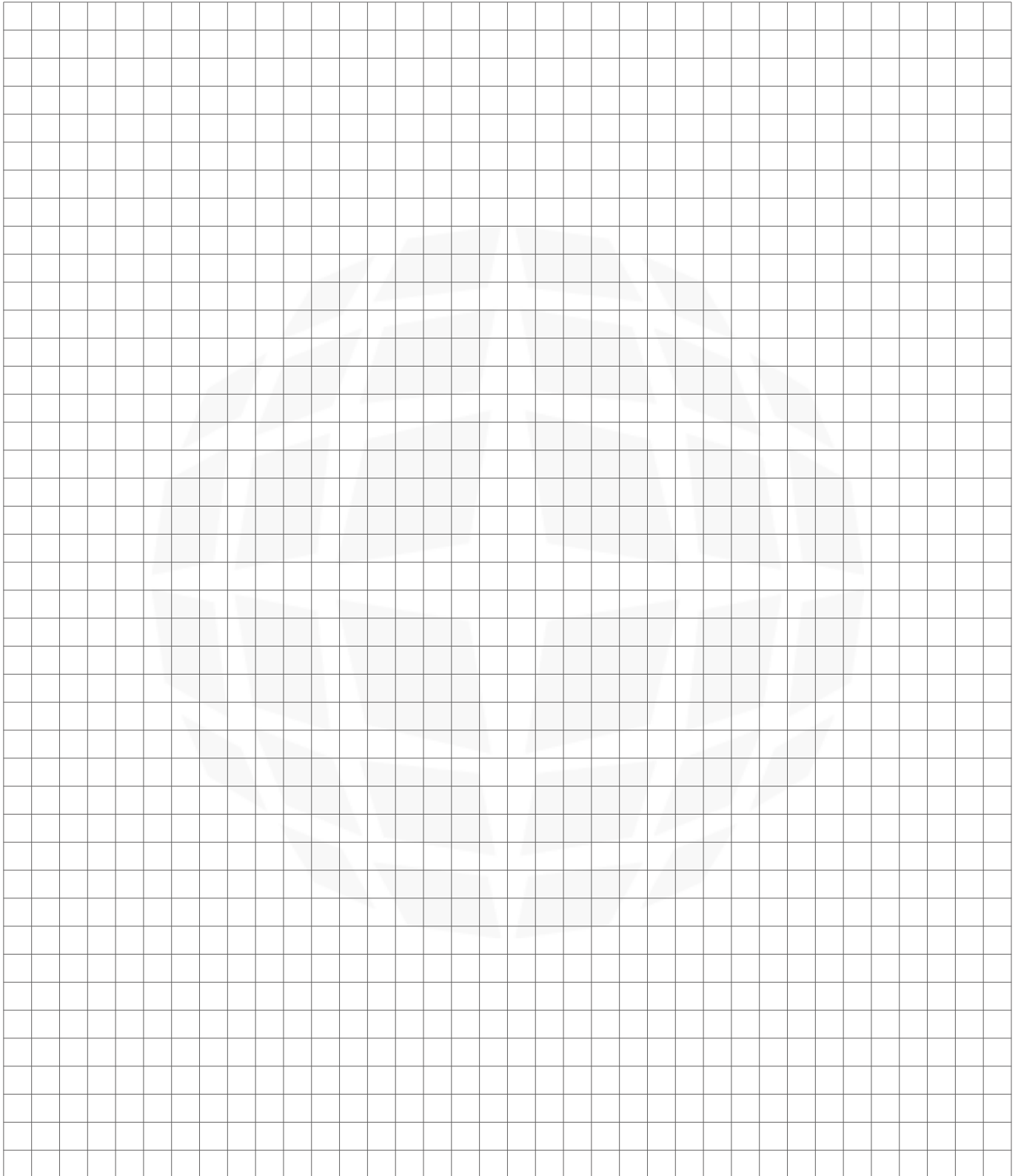

Ermatic® range Continuous ducts covers



40 Pre-sales technical assistance

Ermatic B125

- 42 Recessed covers for concrete infill
- 44 Covers with anti-slip surface

Ermatic C250

- 46 Recessed covers for concrete infill
- 48 Covers with anti-slip surface

Ermatic D400

- 50 Recessed covers for concrete infill
- 52 Covers with anti-slip surface

Ermatic E600

- 54 Recessed covers for concrete infill
- 56 Covers with anti-slip surface

Ermatic F900

- 58 Recessed covers for concrete infill
- 60 Covers with anti-slip surface

Access covers for continuous ducts



The Ermatic® range offers a vast choice of high performance covers designed for convenient and safe access to continuous ducts.

Used frequently in manufacturing facilities, ports and in exhibition halls for example, the covers allow for linear access to every type of underground service (electricity, compressed air, gas, fuels etc.) Ermatic® covers are equally suited to ducts housing industrial machinery such as conveyor belts etc.

Ermatic covers protect ducts against impact damage and the ingress of debris and aggressive chemicals. The range allows the continued and unrestricted use of the surface when installed in trafficked or storage areas.

Regardless of the traffic conditions, Ermatic covers ensure:

- **A quick access** to chambers for inspection , maintenance or repairs
- **Safety** due to the strength and stability of the covers
- **Improved aesthetics:** covers with a recess for infill can be filled with the same material as the surrounding surface to minimise visual impact.



Valencia Port in Spain

Pre-sales technical assistance

The tables and drawings on the following pages specify covers and frames by loading class and type:

- The width of available clear openings from 300mm to 1200mm.
- The method of calculating the desired length using available cover modules
- The overall dimensions of covers and frames
- The recommended dimensions of concrete rebates

In order to correctly specify the cover and installation guidelines, our technical department can supply the following drawings:

- Rebate and concrete construction drawings
- Assembly and marking drawings

It is important that you state the total clear opening length.

Or, if applicable, provide a drawing showing the layout indicating if there are junctions or changes of direction required (see below).

Note:

The covers are designed to open in one direction (←o→). It is therefore important to notify us if continuous runs are interrupted by fixed walls or if ducts terminate on the edges of structures such as kerbs or quays.

- Operation and maintenance, concrete filling of covers, see product details page
- We recommend that we provide technical assistance for the assembly and fixing of large or complex ducts. Please enquire.

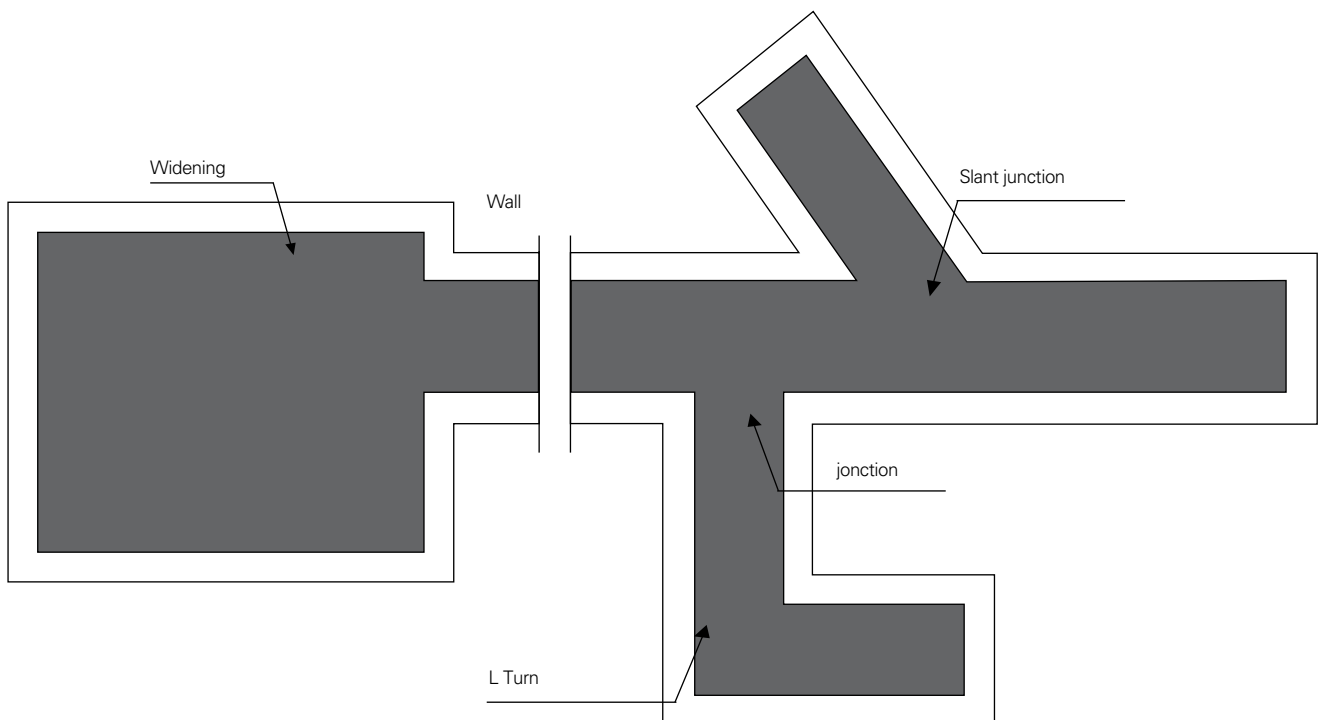

Continuous duct covers recessed for concrete infill B125

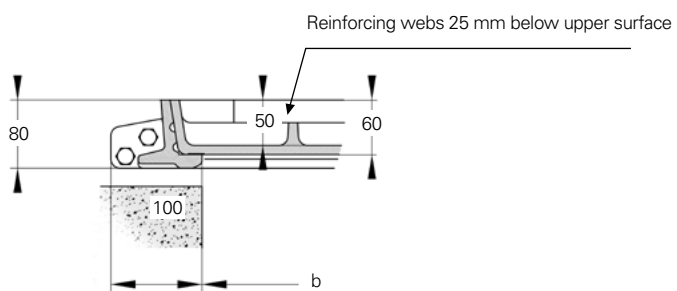
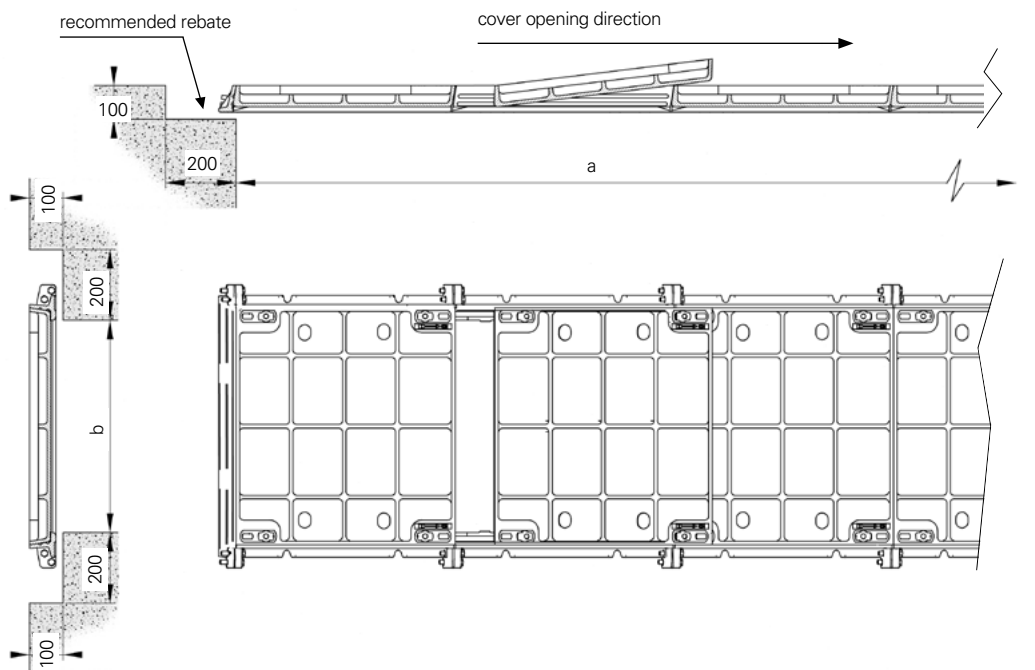

Dimensions in mm
Cover recessed for filling with 40 MPA concrete
See recommendations on p.D8

Continuous duct covers recessed for concrete infill B125

Area of installation

Footways, pedestrian areas and comparable areas, car parks or car parking decks
Group 2 and lower as per EN124

Specification

- ERMATIC B125 access cover and frame
- Cover recessed for concrete infill
- Clear opening (a x b) in mm : **reference ER2R** (a x b)
- Machined vertical and horizontal contact faces
- Ductile cast iron according to ISO 1083 and EN 1563.
- Quality assurance by third party certification to ISO 9001

Options

- Locking by 4 stainless steel bolts
 - Standard locking (VCHC)
 - Security locking (VOTC)
- Level adjusting bolts (see detail on page 10)
- Safety grids (see detail on pages 144-145)

Handling

- Pair of EM keys (weight 8 kg per pair) (see detail on page 13)
See details on handling operation on technical file

Technical file (see pages 87 - 96)

- Installation recommendations
- Rebate preparation
- Installation and shuttering
- Concrete infill
- Operation of covers
- Maintenance
- Full technical specification

clear opening span of the duct b (mm)	length of clear opening of the duct* a (mm)	overall frame dim. length x width x height (mm)	reference
300	(N x 770) - 20 []	(a+110) x (500) x 80	ER2R...030
450	(N1 x 470) + (N2 x 620) + (N3 x 920) - 20 [1 2 3]	(a+110) x (650) x 80	ER2R...045
600	(N1 x 620) + (N2 x 770) + (N3 x 920) - 20 [1 2 3]	(a+110) x (800) x 80	ER2R...060
750	(N1 x 620) + (N2 x 770) - 20 [1 2]	(a+110) x (950) x 80	ER2R...075
900	(N1 x 620) + (N2 x 770) - 20 [1 2]	(a+110) x (1100) x 80	ER2R...090
1000	(N x 520) - 20 []	(a+110) x (1200) x 80	ER2R...100

**The clear opening length of duct covers is calculated by the following method:*

- Use the maximum number of the longest cover part available unless there is a specific need to keep the cover length to a minimum. Smaller covers can be used at the termination of the duct to adjust the clear opening length.
- N is the number of covers.
- 470, 520, 620, 770, 920 is the overall length of covers used.

Options

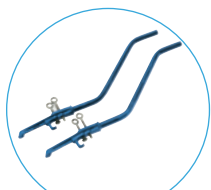

Handling key

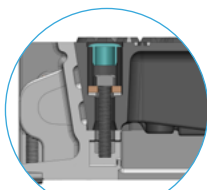

CHC locking

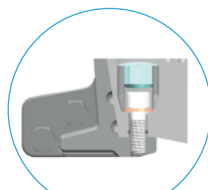

OTC locking

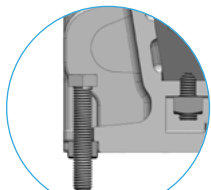

Levelling bolts



Safety grids



Synthetic seal for corrosive environments

Continuous duct covers with solid top anti-slip surface B125

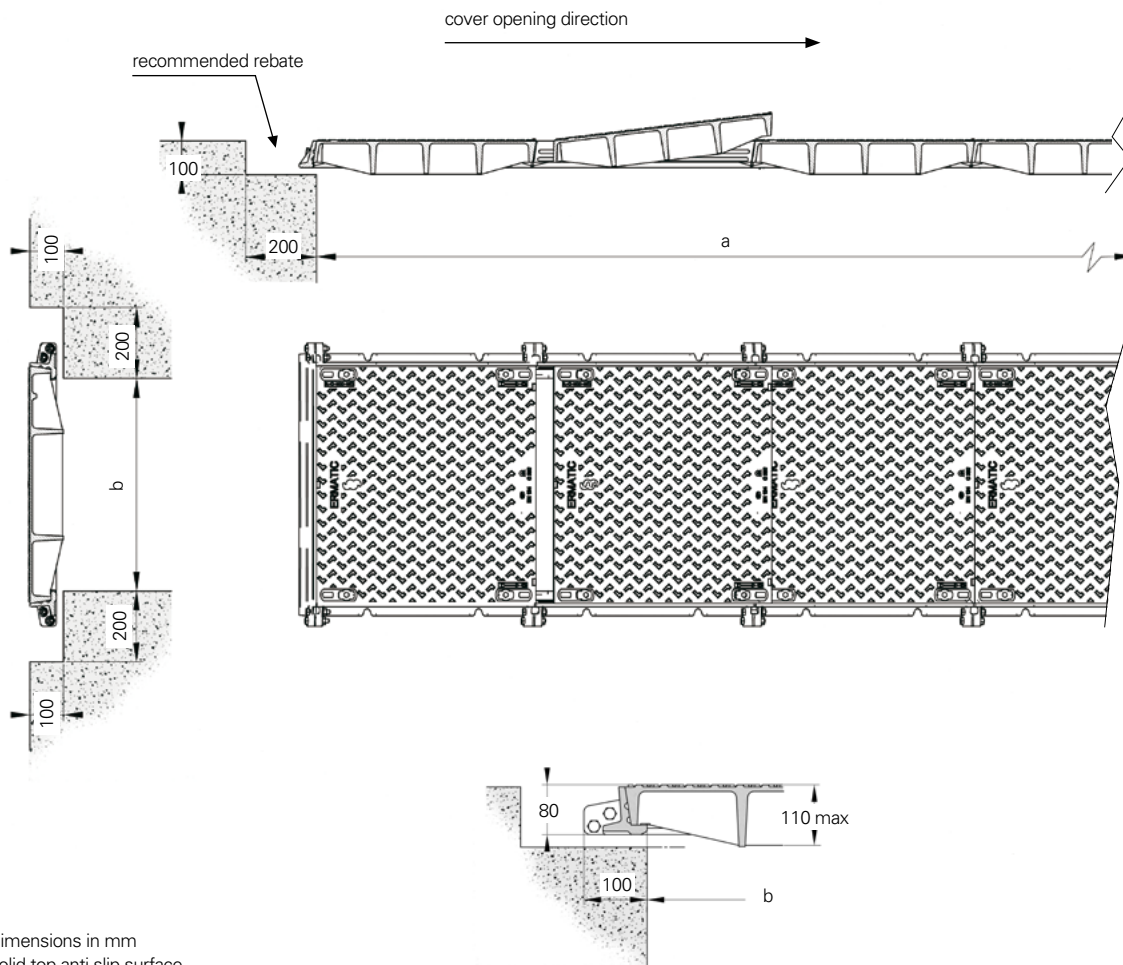

Dimensions in mm
Solid top anti-slip surface

Continuous duct covers with solid top anti-slip surface B125

Area of installation

Footways, pedestrian areas and comparable areas, car parks or car parking decks
Group 2 and lower as per EN124

Specification

- Ermatic B125 access cover and frame
- Solid top cover with anti-slip surface
- Clear opening (a x b) in mm: **reference ER2S** (a x b)
- Machined vertical and horizontal contact faces
- Ductile cast iron according to ISO 1083 and EN 1563.
- Quality assurance by third party certification to ISO 9001

Options

- Locking by 4 stainless steel bolts
 - Standard locking (VCHC)
 - Security locking (VOTC)
- Level adjusting bolts (see detail on page 10)
- Hinged covers (see detail on page 12)
- Safety grids (see detail on pages 144-145)

Handling

- Pair of EM keys (weight 8 kg per pair) (see detail on page 13)
See details on handling operation on technical file

Technical file (see pages 87 - 96)

- Installation recommendations
- Rebate preparation
- Installation and shuttering
- Operation of covers
- Maintenance
- Full technical specification

clear opening span of the duct b (mm)	length of clear opening of the duct* a (mm)	overall frame dim. length x width x height (mm)	reference
300	(N x 320) - 20	(a+110) x (500) x 80	ER2S...030
450	(N x 470) - 20	(a+110) x (650) x 80	ER2S...045
600	(N1 x 620) + (N2 x 770) - 20	(a+110) x (800) x 80	ER2S...060
750	(N x 770) - 20	(a+110) x (950) x 80	ER2S...075
900	(N1 x 620) + (N2 x 770) + (N3 x 920) - 20	(a+110) x (1100) x 80	ER2S...090

**The clear opening length of duct covers is calculated by the following method:*

- Use the maximum number of the longest cover part available unless there is a specific need to keep the cover length to a minimum. Smaller covers can be used at the termination of the duct to adjust the clear opening length.
- N is the number of covers.
- 320, 470, 620, 770, 920 is the overall length of covers used.

Options

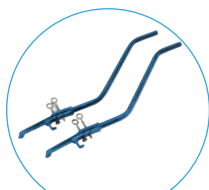

Handling key

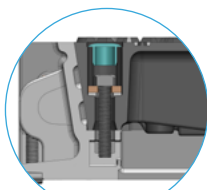

CHC locking

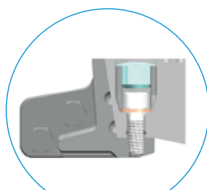

OTC locking

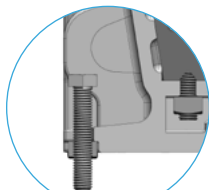

Levelling bolts



Safety grids



Synthetic seal for corrosive environments

Continuous duct covers recessed for concrete infill C250

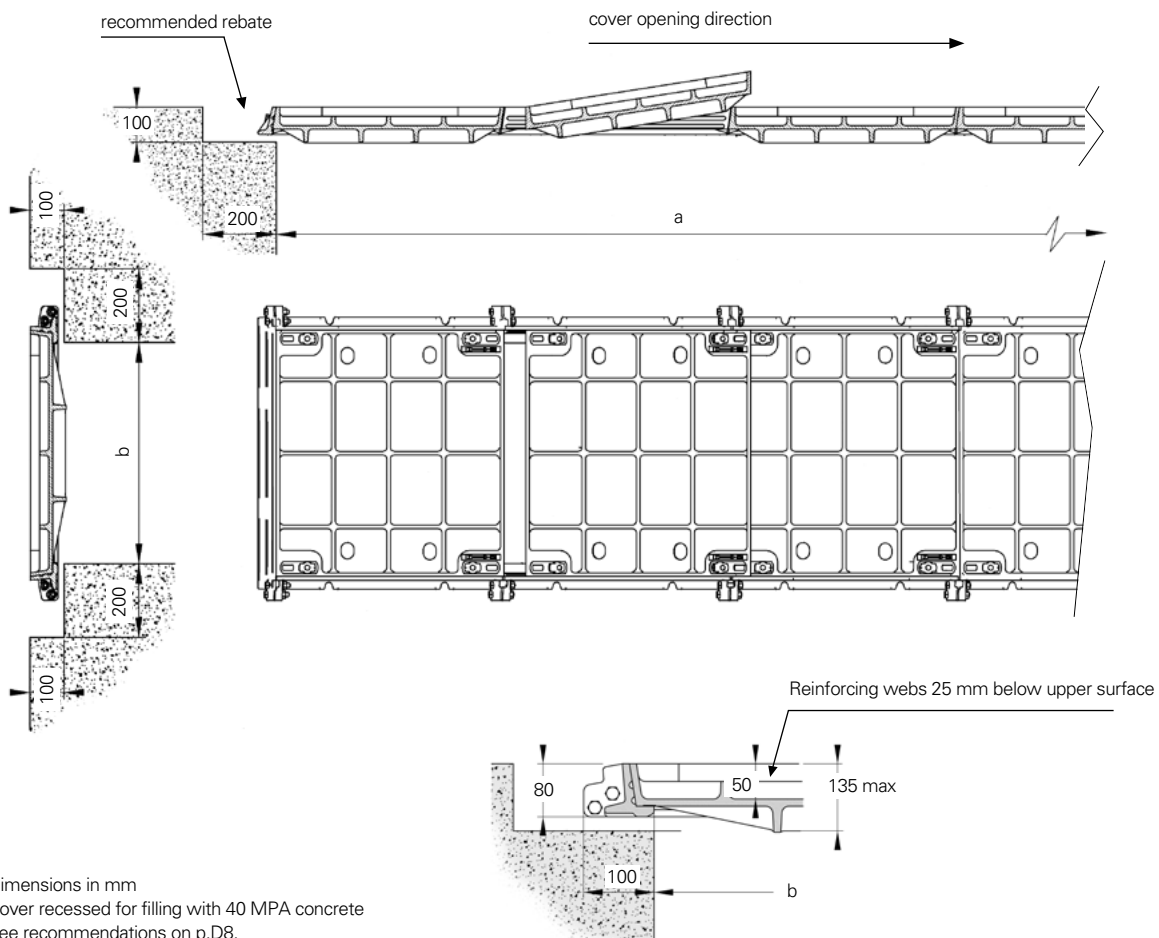
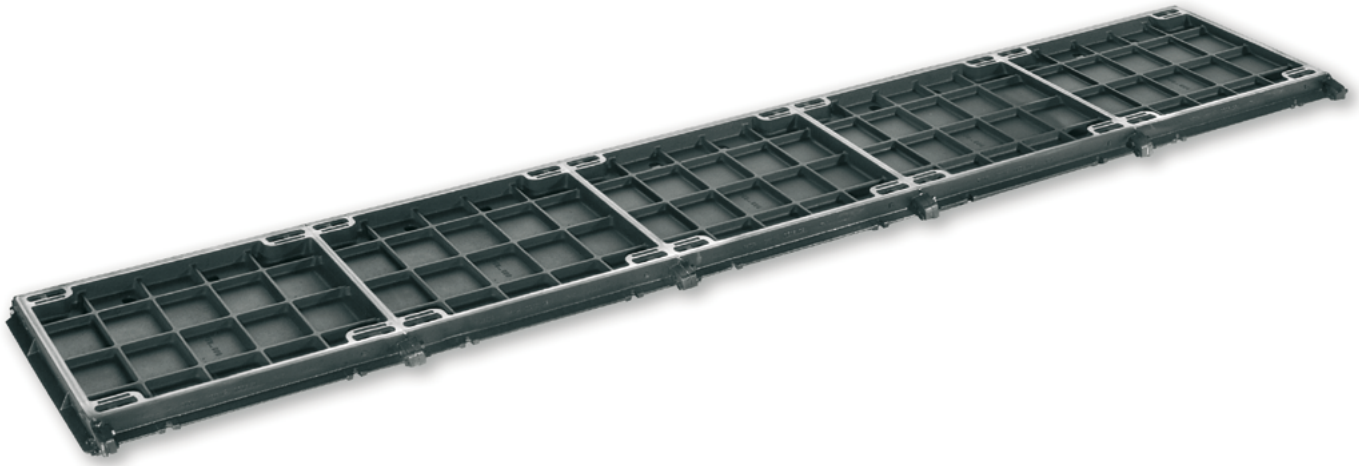

Dimensions in mm
Cover recessed for filling with 40 MPA concrete
See recommendations on p.D8.

Continuous duct covers recessed for concrete infill C250

Area of installation

Parking and yard areas for all types of road vehicles, forecourts and service areas.
Group 3 and lower as per EN124

Specification

- Ermatic C250 access cover and frame
- Cover recessed for concrete infill
- Clear opening (a x b) in mm: **reference ER3R** (a x b)
- Machined vertical and horizontal contact faces
- Ductile cast iron according to ISO 1083 and EN 1563.
- Quality assurance by third party certification to ISO 9001.

Options

- Locking by 4 stainless steel bolts
 - Standard locking (VCHC)
 - Security locking (VOTC)
- Level adjusting bolts (see detail on page 10)
- Safety grids (see detail on pages 144-145)

Handling

- Pair of EM keys (weight 8 kg per pair) (see detail on page 13)
- See details on handling operation on technical file.

Technical file (see pages 87 - 96)

- Installation recommendations
- Rebate preparation
- Installation and shuttering
- Concrete infill
- Operation of covers
- Maintenance
- Full technical specification

clear opening span of the duct b (mm)	length of clear opening of the duct* a (mm)	overall frame dim. length x width x height (mm)	reference
300	(N x 770) - 20	(a+110) x (500) x 80	ER3R...030
450	(N1 x 470) + (N2 x 620) + (N3 x 920) - 20 1 2 3	(a+110) x (650) x 80	ER3R...045
600	(N1 x 620) + (N2 x 770) + (N3 x 920) - 20 1 2 3	(a+110) x (800) x 80	ER3R...060
750	(N1 x 620) + (N2 x 770) - 20 1 2	(a+110) x (950) x 80	ER3R...075
900	(N1 x 620) + (N2 x 770) - 20 1 2	(a+110) x (1100) x 80	ER3R...090
1000	(N x 520) - 20	(a+110) x (1200) x 80	ER3R...100
1200	(N x 770) - 20	(a+180) x (1400) x 20	ER3R...120
600**	(N x 620) - 20	(a+110) x (800) x 80	ER3P...060

*The clear opening length of duct covers is calculated by the following method:

- Use the maximum number of the longest cover part available unless there is a specific need to keep the cover length to a minimum. Smaller covers can be used at the termination of the duct to adjust the clear opening length.
- N is the number of covers.
- 470, 620, 770, 920 is the overall length of covers used.

** Duct covers recessed for paving infill

Options

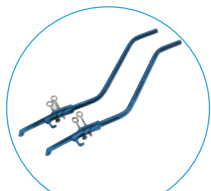

Handling key



CHC locking

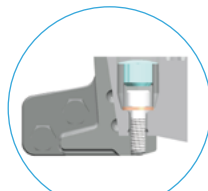

OTC locking

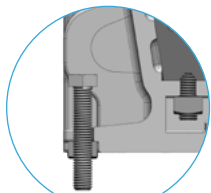

Levelling bolts



Safety grids



Synthetic seal for corrosive environments

Continuous duct covers with solid top anti-slip surface C250

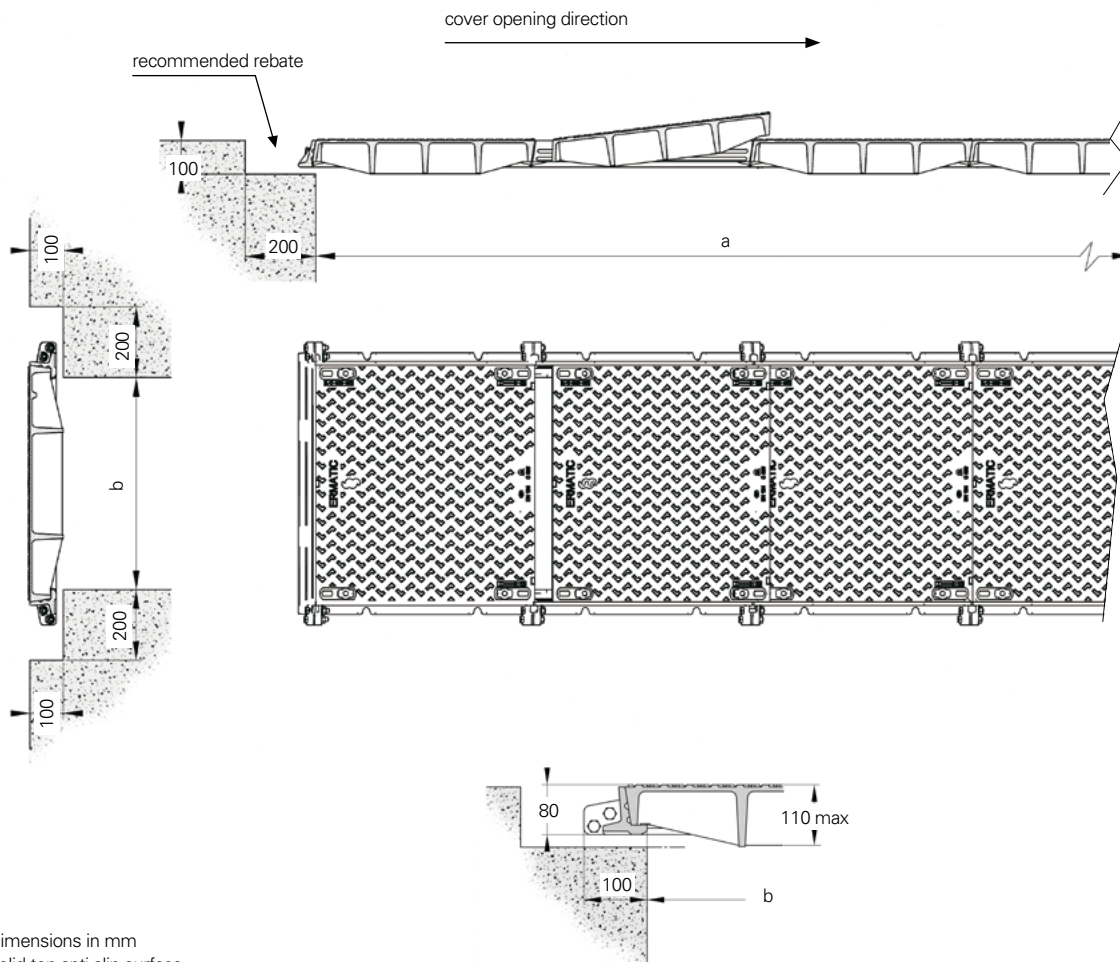

Dimensions in mm
Solid top anti-slip surface

Continuous duct covers with solid top anti-slip surface C250

Area of installation

Parking and yard areas for all types of road vehicles, forecourts and service areas.

Group 3 and lower as per EN124

Specification

- Ermatic C250 Access Cover and frame
- Solid top cover with anti-slip surface
- Clear opening (a x b) in mm: **reference ER3S** (a x b)
- Machined vertical and horizontal contact faces
- Ductile cast iron according to ISO 1083 and EN 1563.
- Quality assurance by third party certification to ISO 9001.

Options

- Locking by 4 stainless steel bolts
 - Standard locking (VCHC)
 - Security locking (VOTC)
- Level adjusting bolts (see detail on page 10)
- Hinged covers (see detail on page 12)
- Safety grids (see detail on pages 144-145)
- Cover with a ø 250mm removable plug

Handling

- Pair of EM keys (weight 8 kg per pair) (see detail on page 13)
- See details on handling operation on technical file.

Technical file (see pages 87 - 96)

- Installation recommendations
- Rebate preparation
- Installation and shuttering
- Operation of covers
- Maintenance
- Full technical specification

clear opening span of the duct b (mm)	length of clear opening of the duct* a (mm)	overall frame dim. length x width x height (mm)	reference
300	(N x 320) - 20	(a+110) x (500) x 80	ER3S...030
450	(N x 470) - 20	(a+110) x (650) x 80	ER3S...045
600	(N x 620) - 20	(a+110) x (800) x 80	ER3S...060
750	(N x 770) - 20	(a+110) x (950) x 80	ER3S...075
900	(N1 x 620) + (N2 x 770) + (N3 x 920) - 20	(a+110) x (1100) x 80	ER3S...090

**The clear opening length of duct covers is calculated by the following method:*

- Use the maximum number of the longest cover part available unless there is a specific need to keep the cover length to a minimum. Smaller covers can be used at the termination of the duct to adjust the clear opening length.

· N is the number of covers

gth of covers used.



Optional: cover with removable plug

Options

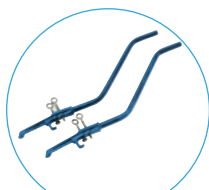

Handling key

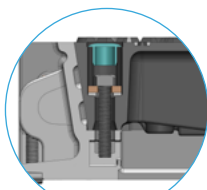

CHC locking

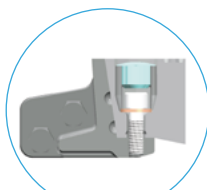

OTC locking

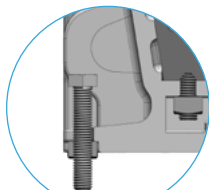

Levelling bolts



Safety grids



Synthetic seal for corrosive environments

Continuous duct covers recessed for concrete infill D400

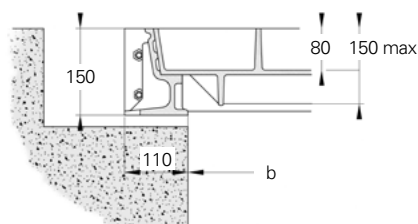
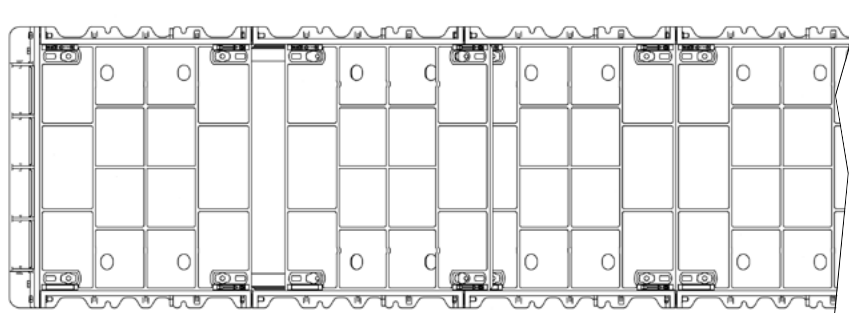
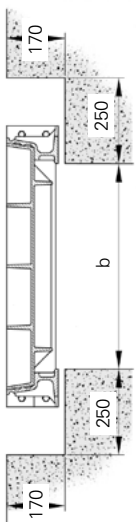
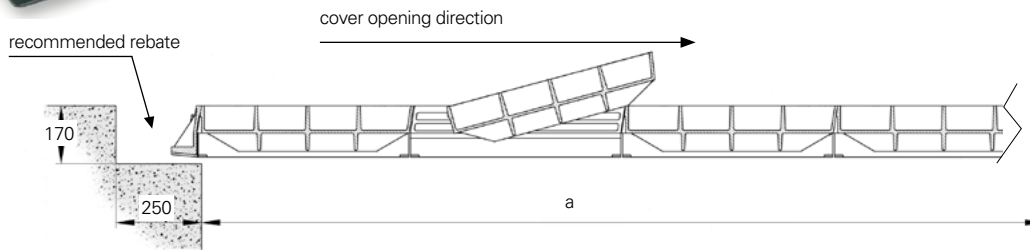

Dimensions in mm
 Cover recessed for filling with 40 MPA concrete
 See recommendations on p.D8.

Continuous duct covers recessed for concrete infill D400

Area of installation

Carriageways of roads (including pedestrian streets), hard shoulders and parking areas for all types of road vehicles. Group 4 and lower as per EN124

Specification

- Ermatic D400 access cover and frame
- Cover recessed for concrete infill
 - Clear opening (a x b) in mm:
 - reference ER5R** (a x b) in cm, 150mm deep frame
 - reference ER4R** (a x b) in cm, 125mm deep frame
- Machined vertical and horizontal contact faces
- Ductile cast iron according to ISO 1083 and EN 1563.
- Quality assurance by third party certification to ISO 9001

Locking

- By 4 stainless steel bolts
- Standard locking (VCHC)

Options

- Level adjusting bolts (see detail on page 10)
- Security locking (VOTC)
- Safety grids (see detail on pages 144-145)

Handling

- Pair of EM keys (weight 8 kg per pair) (see detail on page 13)
- See details on handling operation on technical file.

Technical file (see pages 87 - 96)

- Installation recommendations
- Rebate preparation
- Installation and shuttering
- Concrete infill
- Operation of covers
- Maintenance
- Full technical specification

Options

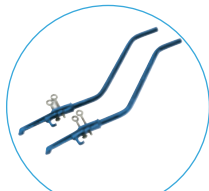

Safety grids

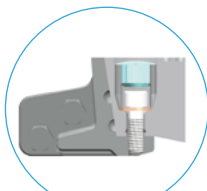

OTC locking

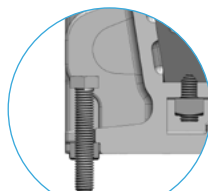

Levelling bolts



Safety grids



Synthetic seal for corrosive environments

clear opening span of the duct b (mm)	length of clear opening of the duct* a (mm)	overall frame dim. length x width x height (mm)	reference
600	(N x 620) + (N2 x 770) - 20 1 2	(a+170) x (820) x 150	ER5R...060 VCHC
750**	(N1 x 770) - 20	(a+110) x (930) x 125	ER4R...075 VCHC
750	(N1 x 620) + (N2 x 770) - 20 1 2	(a+170) x (970) x 150	ER5R...075 VCHC
800**	(N x 820) - 20	(a+170) x (980) x 125	ER4R...080 VCHC
900**	(N x 920) - 20	(a+170) x (1080) x 125	ER4R...090 VCHC
900	(N1 x 620) + (N2 x 770) - 20 1 2	(a+170) x (1120) x 150	ER5R...090 VCHC
1000	(N x 520) - 20	(a+170) x (1220) x 150	ER5R...100 VCHC
1200	(N x 770) - 20	(a+170) x (1380) x 125	ER4R...120 VCHC

*The clear opening length of duct covers is calculated by the following method:

- Use the maximum number of the longest cover part available unless there is a specific need to keep the cover length to a minimum. Smaller covers can be used at the termination of the duct to adjust the clear opening length.

· N is the number of covers.

· 520, 620, 770, 820, 920 is the overall length of covers used.

**See plans for these references on next page.

Continuous duct covers with solid top anti-slip surface D400

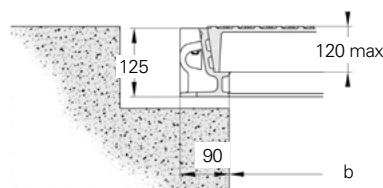
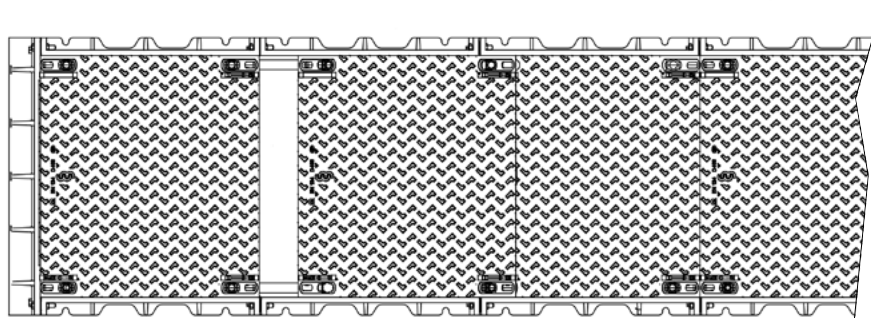
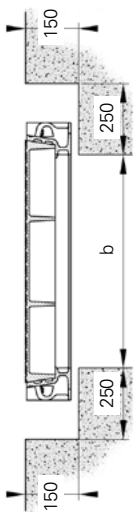
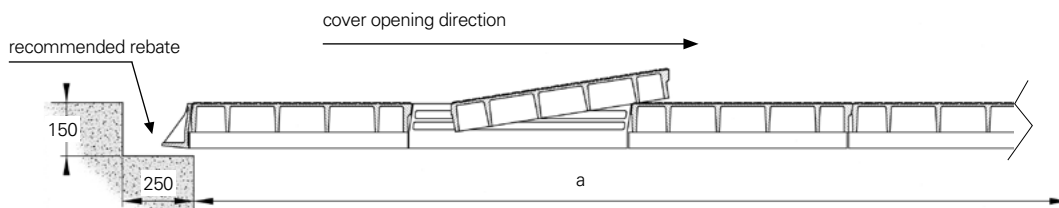
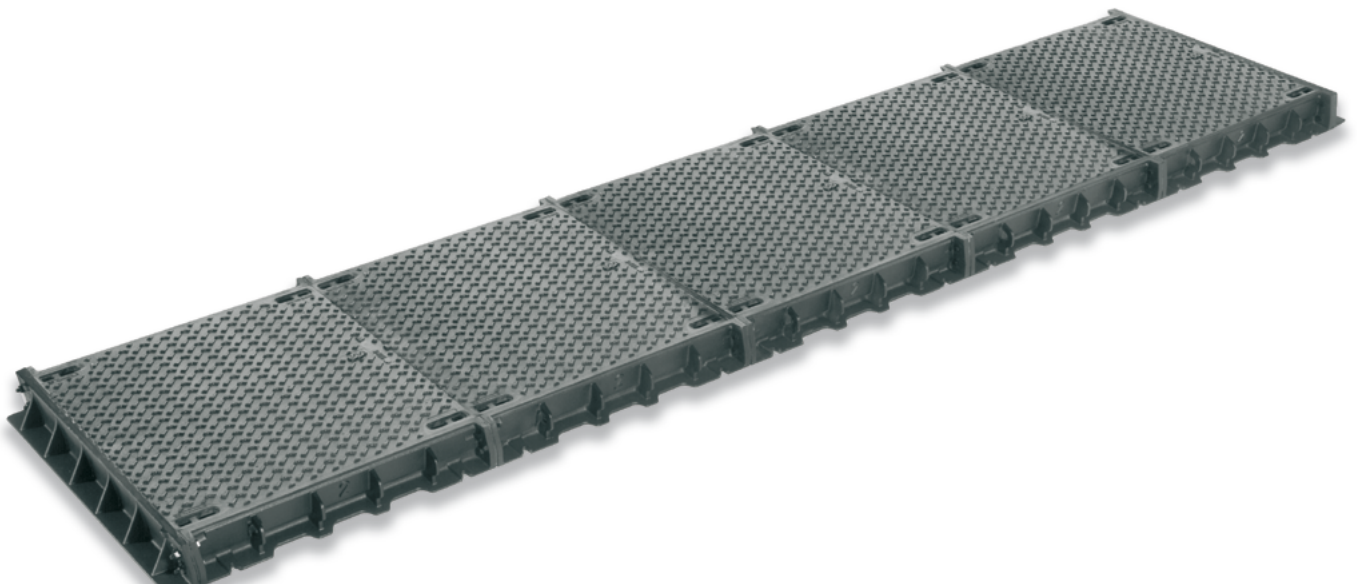

Dimensions in mm
Solid top anti-slip surface

Continuous duct covers with solid top anti-slip surface D400

Area of installation

Carriageways of roads (including pedestrian streets), hard shoulders and parking areas for all types of road vehicles. Group 4 and lower as per EN124

Specification

- Ermatic D400 access cover and frame
- Solid to cover with anti-slip surface
- Clear opening (a x b) in mm: **reference ER4S** (a x b)
- Machined vertical and horizontal contact faces
- Ductile cast iron according to ISO 1083 and EN 1563.
- Quality assurance by third party certification to ISO 9001

Locking

- By 4 stainless steel bolts
- Standard locking (VCHC)

Options

- Level adjusting bolts (see detail on page 10)
- Security locking (VOTC)
- Hinged and assisted opening by strut. (see details on page 12)
- Safety grids (see detail on pages 144-145)

Handling

- Pair of EM keys (weight 8 kg per pair) (see details on page 13)
- See details on handling operation on technical file.

Technical file (see pages 87 - 96)

- Installation recommendations
- Rebate preparation
- Installation and shuttering
- Operation of covers
- Maintenance
- Full technical specification

clear opening span of the duct b (mm)	length of clear opening of the duct* a (mm)	overall frame dim. length x width x height (mm)	reference
450	(N x 470) - 20	(a+170) x (630) x 125	ER4S...045 VCHC
600	(N x 620) - 20	(a+170) x (780) x 125	ER4S...060 VCHC
750	(N x 770) - 20	(a+170) x (930) x 125	ER4S...075 VCHC
800	(N x 820) - 20	(a+170) x (980) x 125	ER4S...080 VCHC
900	(N1 x 620) + (N2 x 920) - 20	(a+170) x (1080) x 125	ER4S...090 VCHC
1000	(N x 1020) - 20	(a+170) x (1180) x 125	ER4S...100 VCHC

**The clear opening length of duct covers is calculated by the following method:*

- Use the maximum number of the longest cover part available unless there is a specific need to keep the cover length to a minimum. Smaller covers can be used at the termination of the duct to adjust the clear opening length.
- N is the number of covers.
- 470, 620, 770, 820, 920, 1020 is the overall length of covers used.

Options

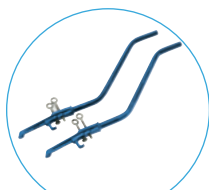

Handling key

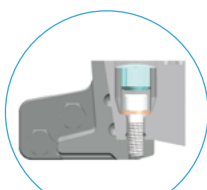

OTC locking

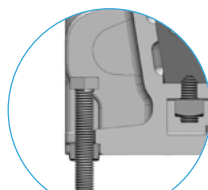

Levelling bolts



Safety grids



Synthetic seal for corrosive environments

Continuous duct covers recessed for concrete infill E600

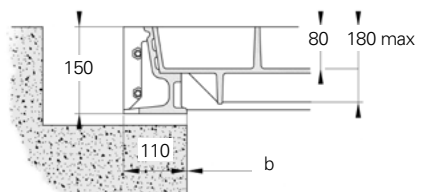
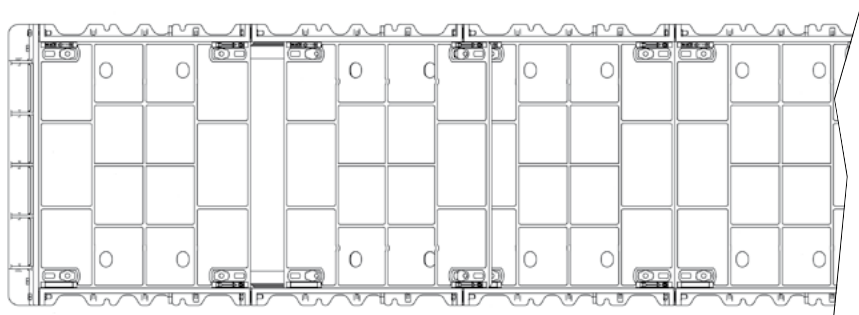
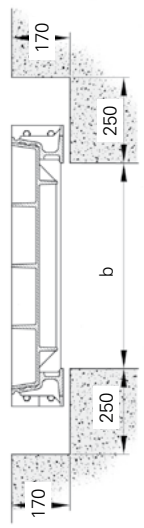
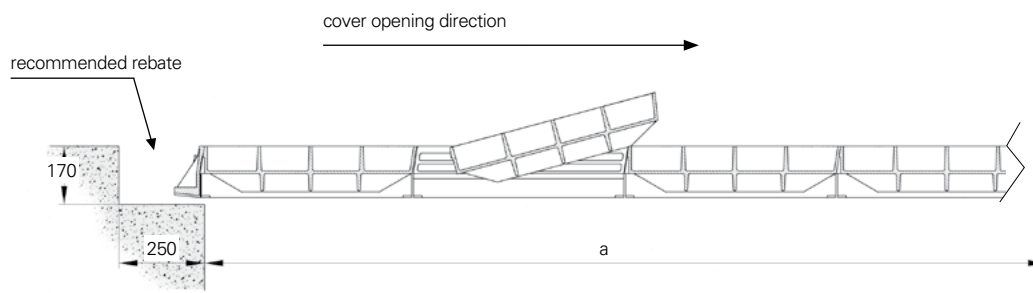
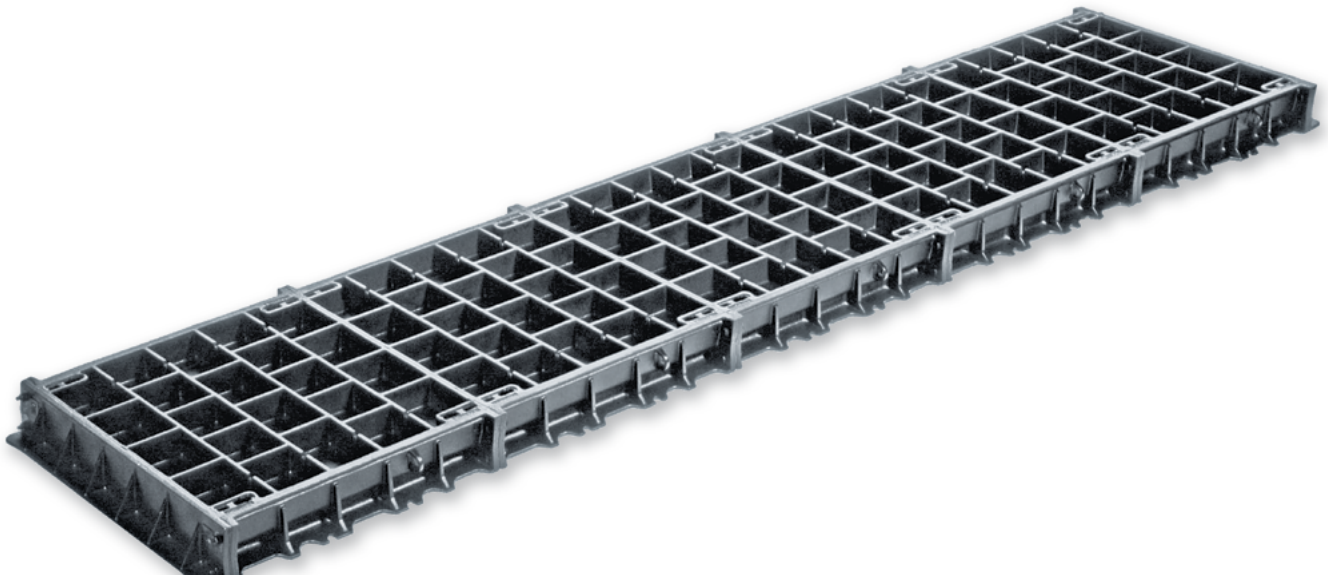

Dimensions in mm
Cover recessed for filling with 40 MPA concrete
See recommendations on p. D8

Continuous duct covers recessed for concrete infill E600

Area of installation

Areas imposing high wheel loads e.g. docks, aircraft pavements.
Group 5 and lower as per EN124

Specification

- Ermatic E600 access cover and frame
- Cover recessed for concrete infill
- Clear opening (a x b) in mm: **reference ER6R** (a x b)
- Machined vertical and horizontal contact faces
- Ductile cast iron according to ISO 1083 and EN 1563.
- Quality assurance by third party certification to ISO 9001.

Options

- Recommended: locking by 4 stainless steel bolts
 - Standard locking (VCHC)
 - Security locking (VOTC)
- Level adjusting bolts (see detail on page 10)
- Safety grids (see detail on pages 144-145)

Handling

- Pair of EM keys (weight 8 kg per pair).
See details on handling operation on technical file.

Technical file (see pages 87 - 96)

- Installation recommendations
- Rebate preparation
- Installation and shuttering
- Concrete infill
- Operation of covers
- Maintenance
- Full technical specification

clear opening span of the duct b (mm)	length of clear opening of the duct* a (mm)	overall frame dim. length x width x height (mm)	reference
600	(N1 x 620) + (N2 x 770) - 20 1 2	(a+170) x (820) x 150	ER6R...060
750	(N1 x 620) + (N2 x 770) - 20 1 2	(a+170) x (970) x 150	ER6R...075
900	(N1 x 620) + (N2 x 770) - 20 1 2	(a+170) x (1120) x 150	ER6R...090
1000	(N x 520) - 20	(a+170) x (1220) x 150	ER6R...100
1200	(N x 770) - 20	(a+170) x (1420) x 150	ER6R...120

**The clear opening length of duct covers is calculated by the following method:*

- Use the maximum number of the longest cover part available unless there is a specific need to keep the cover length to a minimum. Smaller covers can be used at the termination of the duct to adjust the clear opening length.
- N is the number of covers.
- 520, 620, 770, is the overall length of covers used.

Options

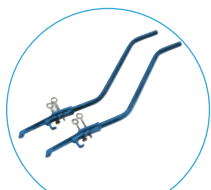

Handling key

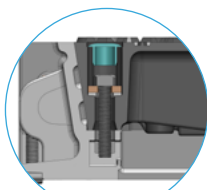

CHC locking

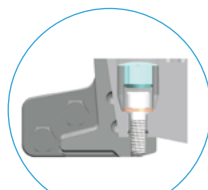

OTC locking

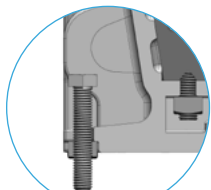

Levelling bolts



Safety grids



Synthetic seal for corrosive environments

Continuous duct covers with solid top anti-slip surface E600

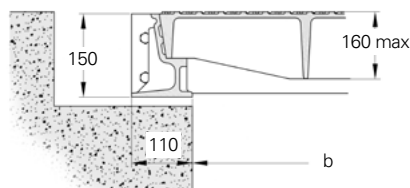
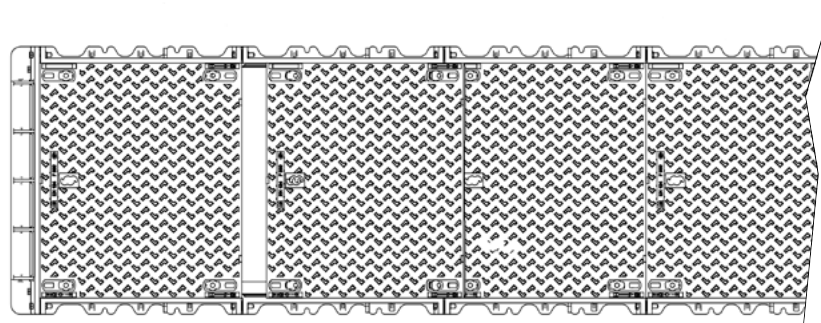
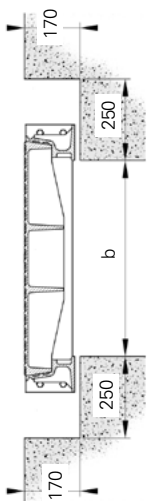
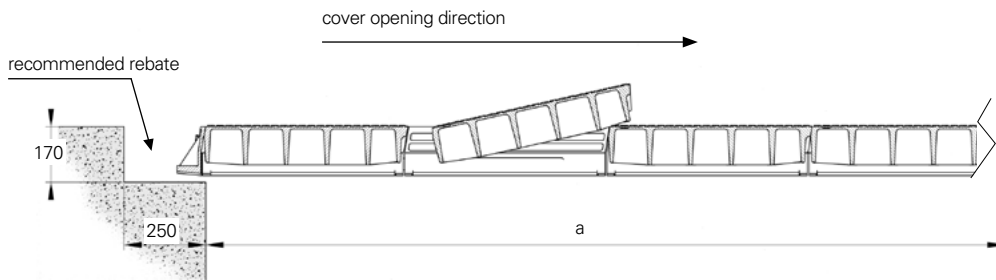
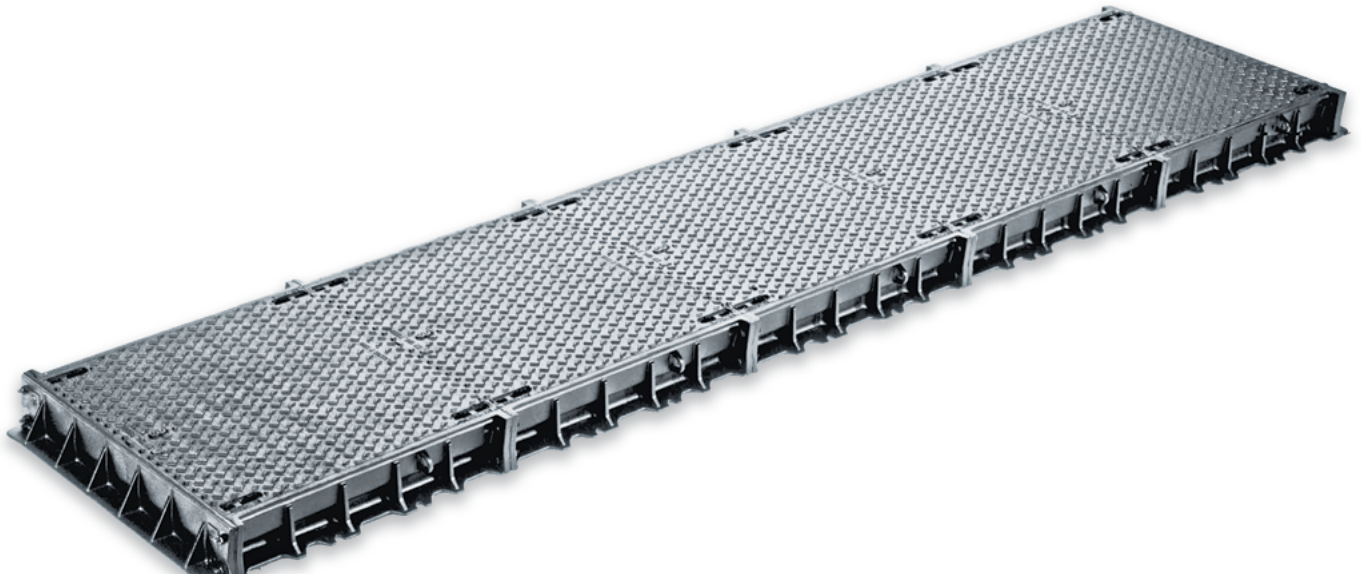

Dimensions in mm
Solid top anti-slip surface

Continuous duct covers with solid top anti-slip surface E600

Area of installation

Areas imposing high wheel loads e.g. docks, aircraft pavements.
Group 5 and lower as per EN124

Specification

- Ermatic E600 access cover and frame
- Cover with solid top anti-slip surface
- Clear opening (a x b) in mm: **reference ER6S** (a x b)
- Machined vertical and horizontal contact faces
- Ductile cast iron according to ISO 1083 and EN 1563.
- Quality assurance by third party certification to ISO 9001.

Options

- Recommended: locking by 4 stainless steel bolts
 - Standard locking (VCHC)
 - Security locking (VOTC)
- Level adjusting bolts (see detail on page 10)
- Hinged and assisted opening by strut (see details on page 12)
- Safety grids (see detail on pages 144-145)

Handling

- Pair of EM keys (weight 8 kg per pair) (see detail on page 13)
See details on handling operation on technical file.

Technical file (see pages 87 - 96)

- Installation recommendations
- Rebate preparation
- Installation and shuttering
- Operation of covers
- Maintenance
- Full technical specification

clear opening span of the duct b (mm)	length of clear opening of the duct* a (mm)	overall frame dim. length x width x height (mm)	reference
600	(N1 x 620) + (N2 x 770) - 20 1 2	(a+170) x (820) x 150	ER6S...060
750	(N1 x 620) + (N2 x 770) - 20 1 2	(a+170) x (970) x 150	ER6S...075
900	(N1 x 620) + (N2 x 770) + (N3 x 920) - 20 1 2 3	(a+170) x (1120) x 150	ER6S...090

**The clear opening length of duct covers is calculated by the following method:*

- Use the maximum number of the longest cover part available unless there is a specific need to keep the cover length to a minimum. Smaller covers can be used at the termination of the duct to adjust the clear opening length.
- N is the number of covers.
- 620, 770, 920, is the overall length of covers used.

Options

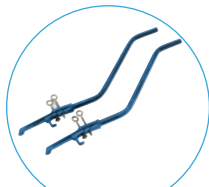

Handling key

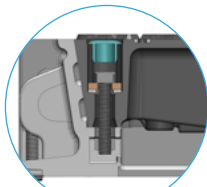

CHC locking

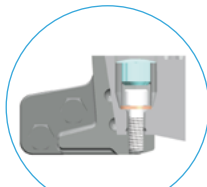

OTC locking

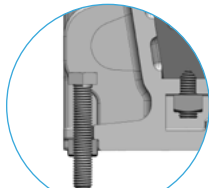

Levelling bolts



Safety grids



Synthetic seal for corrosive environments

Continuous duct covers recessed for concrete infill F900

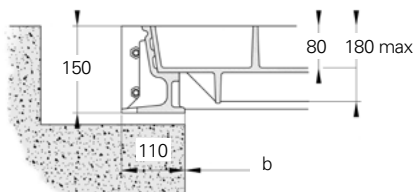
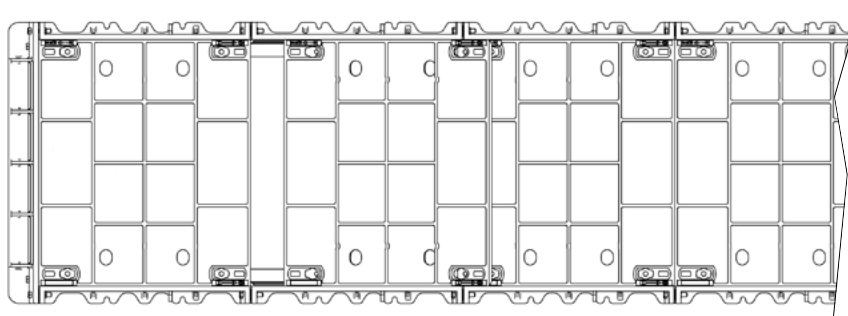
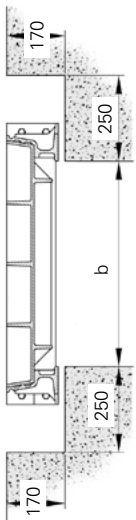
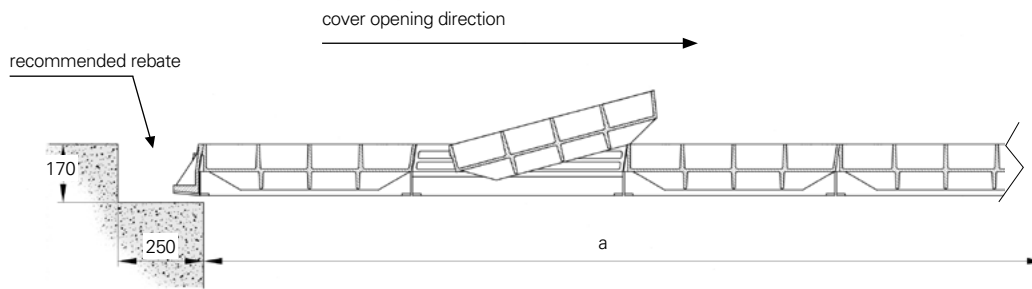
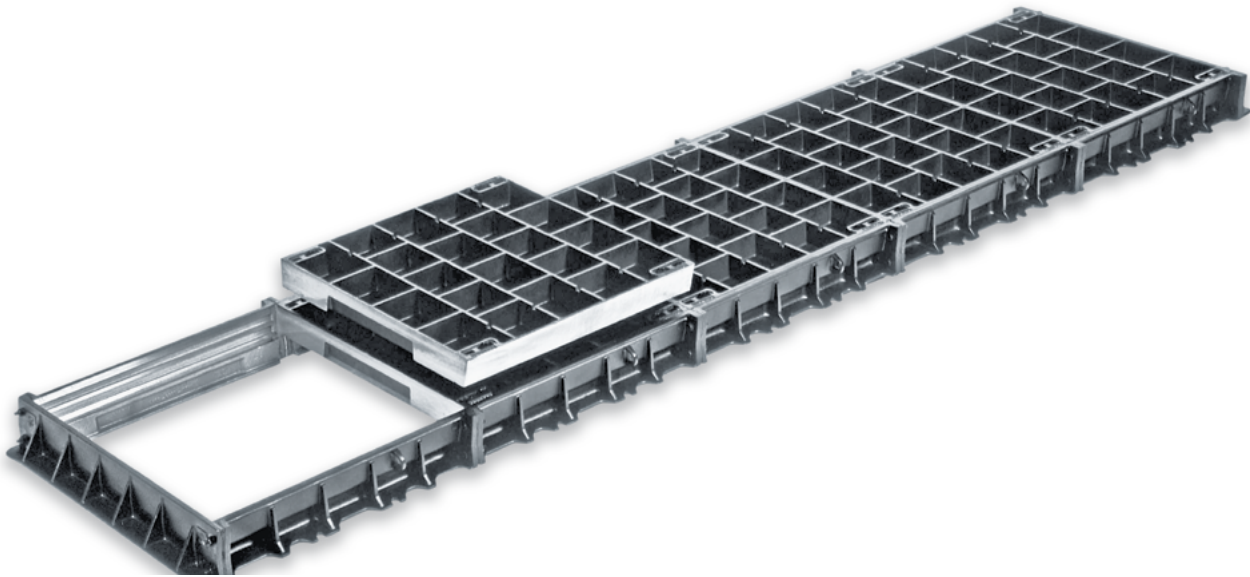

Dimensions in mm
 Cover recessed for filling with 40 MPA concrete
 See recommendations on p.D8.

Continuous duct covers recessed for concrete infill F900

Area of installation

Areas imposing particularly high wheel loads e.g. docks, aircraft pavements.
Group 6 and lower as per EN124

Specification

- Ermatic F900 access cover and frame
- Cover recessed for concrete infill
- Clear opening (a x b) in mm: **reference ER9R** (a x b)
- Machined vertical and horizontal contact faces
- Ductile cast iron according to ISO 1083 and EN 1563.
- Quality assurance by third party certification to ISO 9001.

Options





- Recommended: locking by 4 stainless steel bolts
 - Standard locking (VCHC)
 - Security locking (VOTC)
- Level adjusting bolts (see detail on page 10)
- Safety grids (see detail on pages 144-145)

Handling

- Pair of EM keys (weight 8 kg per pair) (see detail on page 13)
- See details on handling operation on technical file.

Technical file (see pages 87 - 96)

- Installation recommendations
- Rebate preparation
- Installation and shuttering
- Concrete infill
- Operation of covers
- Maintenance
- Full technical specification

clear opening span of the duct b (mm)	length of clear opening of the duct* a (mm)	overall frame dim. length x width x height (mm)	reference
600	(N1 x 620) + (N2 x 770) - 20 	(a+170) x (820) x 150	ER9R...060
750	(N1 x 620) + (N2 x 770) - 20 	(a+170) x (970) x 150	ER9R...075
900	(N1 x 620) + (N2 x 770) - 20 	(a+170) x (1120) x 150	ER9R...090
1000	(N x 520) - 20 	(a+170) x (1220) x 150	ER9R...100
1200	(N x 770) - 20 	(a+170) x (1420) x 150	ER9R...120

**The clear opening length of duct covers is calculated by the following method:*

- Use the maximum number of the longest cover part available unless there is a specific need to keep the cover length to a minimum. Smaller covers can be used at the termination of the duct to adjust the clear opening length.
- N is the number of covers.
- 520, 620, 770, is the overall length of covers used.

Options

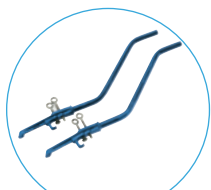

Handling key

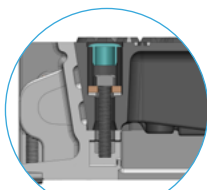

CHC locking

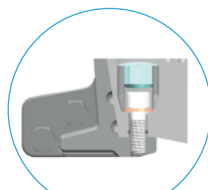

OTC locking

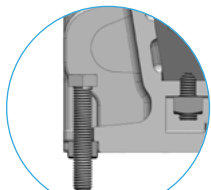

Levelling bolts



Safety grids



Synthetic seal for corrosive environments

Continuous duct covers with solid top anti-slip surface F900

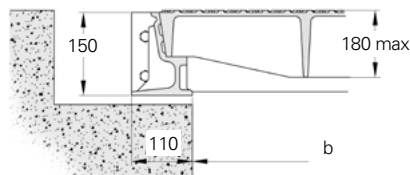
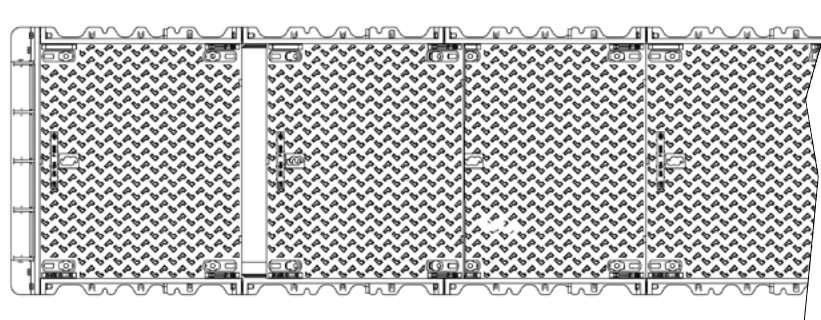
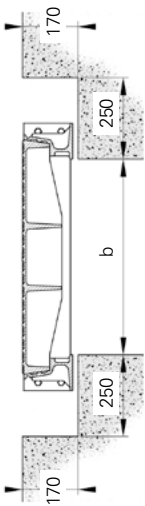
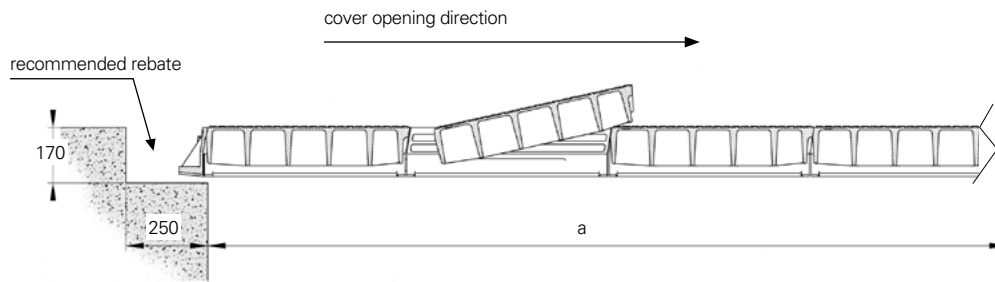
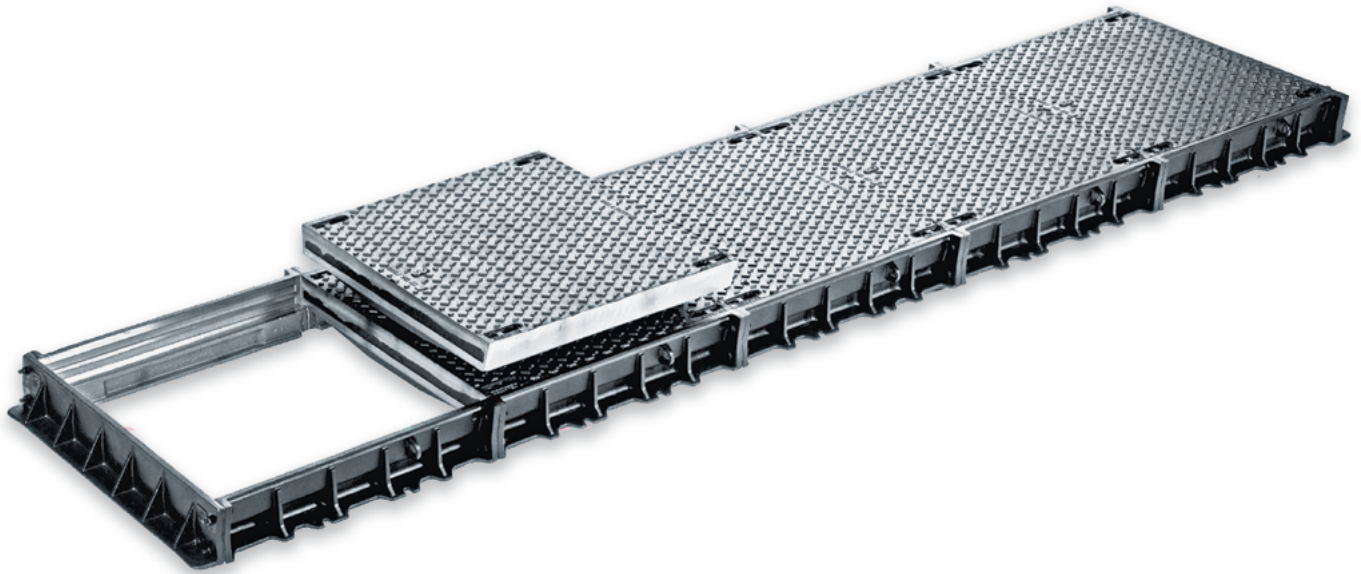

Dimensions in mm
Solid top anti-slip surface

Continuous duct covers with solid top anti-slip surface F900

Area of installation

Areas imposing particularly high wheel loads e.g. docks, aircraft pavements.

Group 6 and lower as per EN124

Specification

- Ermatic F900 access cover and frame
- Solid top cover with anti-slip surface
- Clear opening (a x b) in mm: **reference ER9S** (a x b)
- Machined vertical and horizontal contact faces
- Ductile cast iron according to ISO 1083 and EN 1563.
- Quality assurance by third party certification to ISO 9001

Options

- Recommended: locking by 4 stainless steel bolts
 - Standard locking (VCHC)
 - Security locking (VOTC)
- Level adjusting bolts (see detail on page 10)
- Hinged and assisted opening by strut (see detail on page 12)
- Safety grids (see detail on pages 144-145)
- Cover with a ø 280 x 230mm hinged plug opening.

Handling

- Pair of EM keys (weight 8 kg per pair) (see detail on page 13)
- See details on handling operation on technical file.

Technical file (see pages 87 - 96)

- Installation recommendations
- Rebate preparation
- Installation and shuttering
- Operation of covers
- Maintenance
- Full technical specification

clear opening span of the duct b (mm)	length of clear opening of the duct* a (mm)	overall frame dim. length x width x height (mm)	reference
600	(N1 x 620) + (N2 x 770) - 20 1 2	(a+170) x (820) x 150	ER9S...060
750	(N1 x 620) + (N2 x 770) - 20 1 2	(a+170) x (970) x 150	ER9S...075
900	(N1 x 620) + (N2 x 770) + (N3 x 920) - 20 1 2 3	(a+170) x (1120) x 150	ER9S...090

**The clear opening length of duct covers is calculated by the following method:*

- Use the maximum number of the longest cover part available unless there is a specific need to keep the cover length to a minimum. Smaller covers can be used at the termination of the duct to adjust the clear opening length.
- N is the number of covers.
- 620, 770, 920, is the overall length of covers used.



Hinged hydrant plug cover

Options

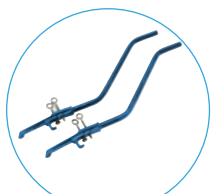

Handling key



CHC locking

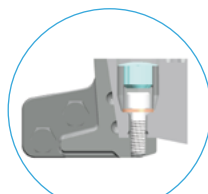

OTC locking

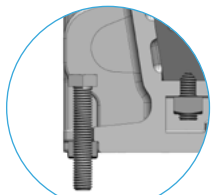

Levelling bolts



Safety grids



Synthetic seal for corrosive environments

Notes

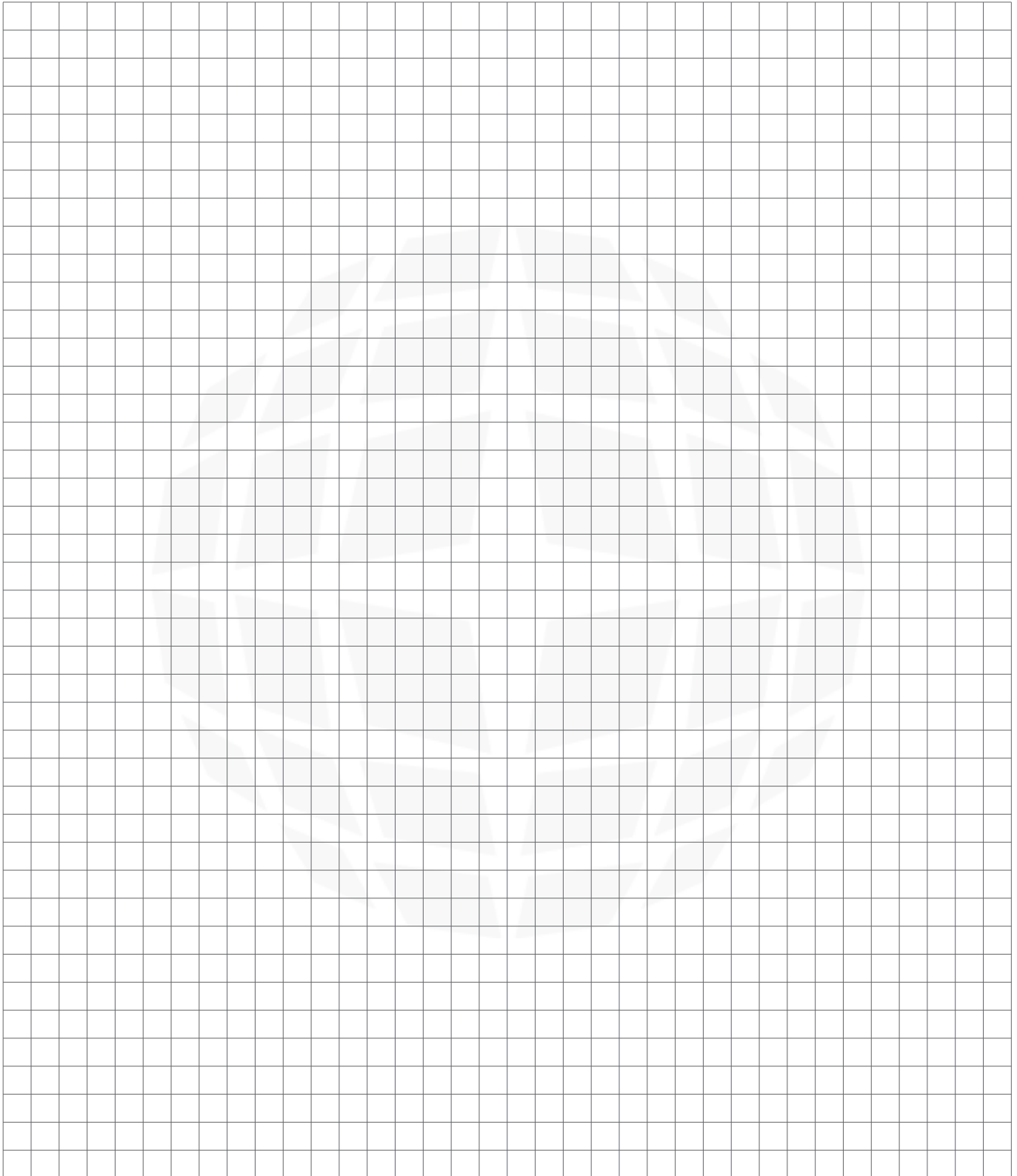

Ermatic® range Covers with removable beams



64 Pre-sales technical assistance

Ermatic B125

66 Recessed covers for concrete infill
68 Covers with anti-slip surface

Ermatic C250

70 Recessed covers for concrete infill
72 Covers with anti-slip surface

Ermatic D400

74 Recessed covers for concrete infill
76 Covers with anti-slip surface

Ermatic E600

78 Recessed covers for concrete infill
80 Covers with anti-slip surface

Ermatic F900

82 Recessed covers for concrete infill
84 Covers with anti-slip surface

Access covers with removable beams

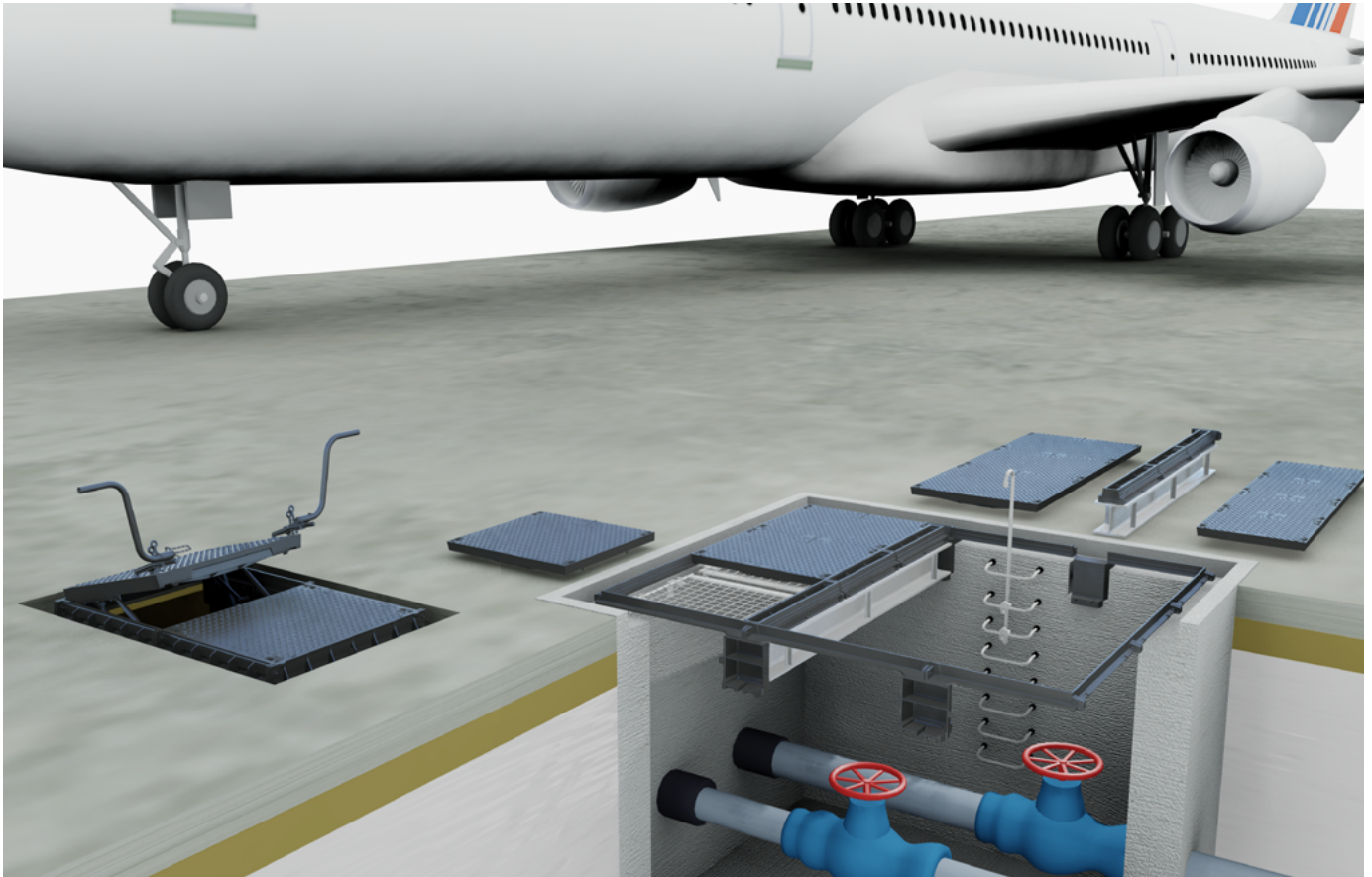

Large chambers are necessary for cable drawpits manifold chambers, and for servicing large items of machinery.

Beamed multiple Ermatic covers ensure complete, unobstructed access to chambers from 1220mm span and above.

They are constructed from standard covers, with seating and sealing on intermediate removable support beams.

These covers are available in different loading classes, in a wide variety of sizes from 1220mm long x 1370mm span.

Pre-sales technical assistance

The tables and drawings on the following pages enable you to specify by loading class and surface finish, for clear openings between 1220 x 1370mm up to 3660 x 5180mm.

The tables will show:

- the number of covers and beams per unit
- the orientation of the beam
- the recommended rebate dimensions prior to installation

For further assistance please contact our Technical Department with the following details:

- the required load class and place of installation
- the desired surface finish
- the clear opening required (and the type of equipment : pumps, screens, valves, etc.)
- the fall protection strategy

If available, please supply the detailed project drawings.

Note

Covers and frames are designed with removable beams fitted in housing boxes located under the frame.

Therefore whenever the product is not installed on top of a solid and continuous wall structure, it is important to design an appropriate bearing structure (concrete beam for example).

The covers are designed to open in one direction
It is therefore important to notify us if fixed walls interrupt multiple covers or if the unit abuts upon the edges of structures such as kerbs or quays.

Please refer to our comprehensive technical file at the end of this section. These details are not suitable for the installation of large beamed solutions, on site technical assistance can be provided
Please enquire with our technical team for details.

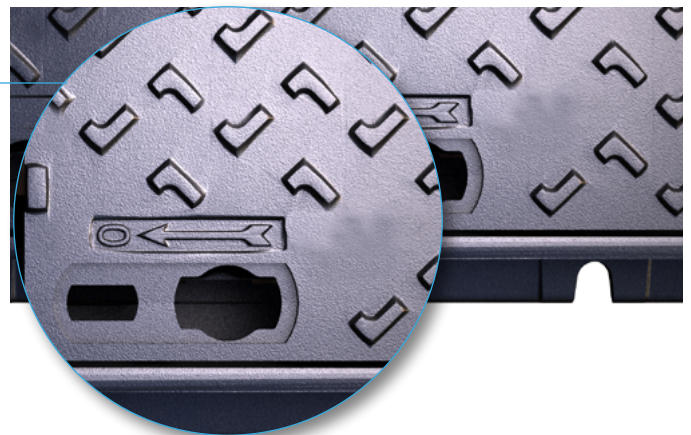

Multiple covers with removable beams recessed for concrete infill B125

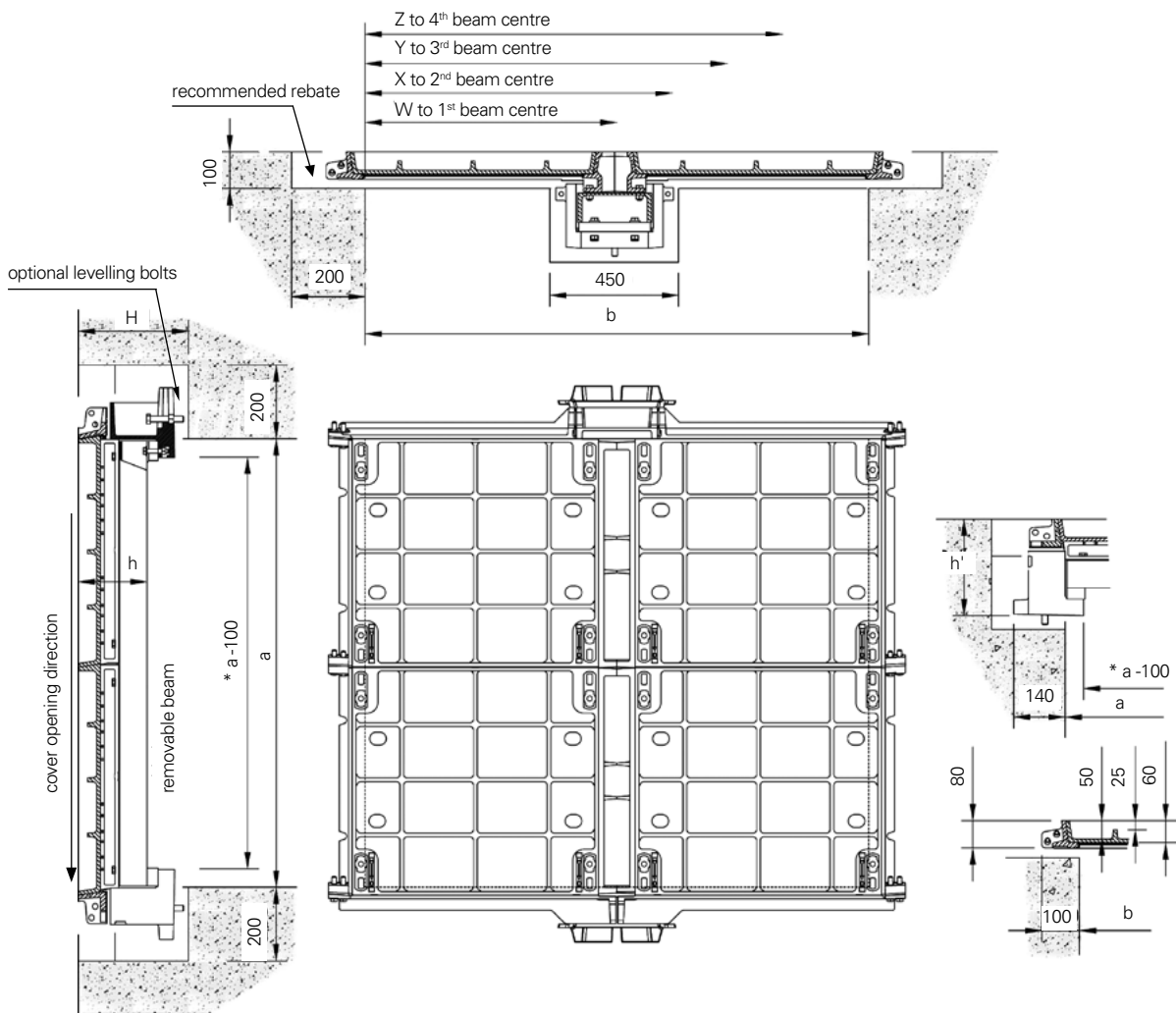

Dimensions in mm

Cover recessed for filling with 40 MPA concrete
See technical file on p.D 8

Multiple covers with removable beams: solid top anti-slip surface B125

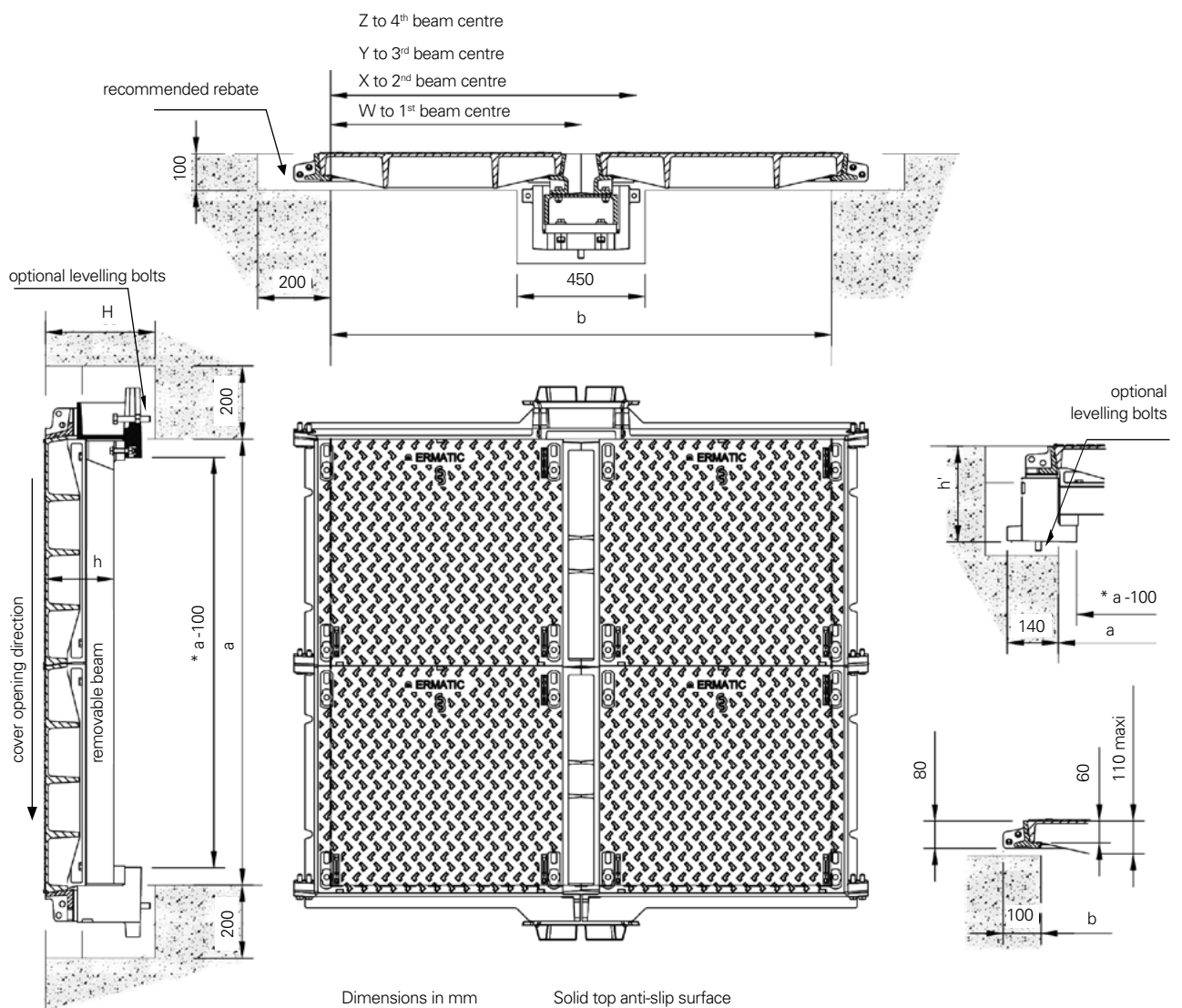
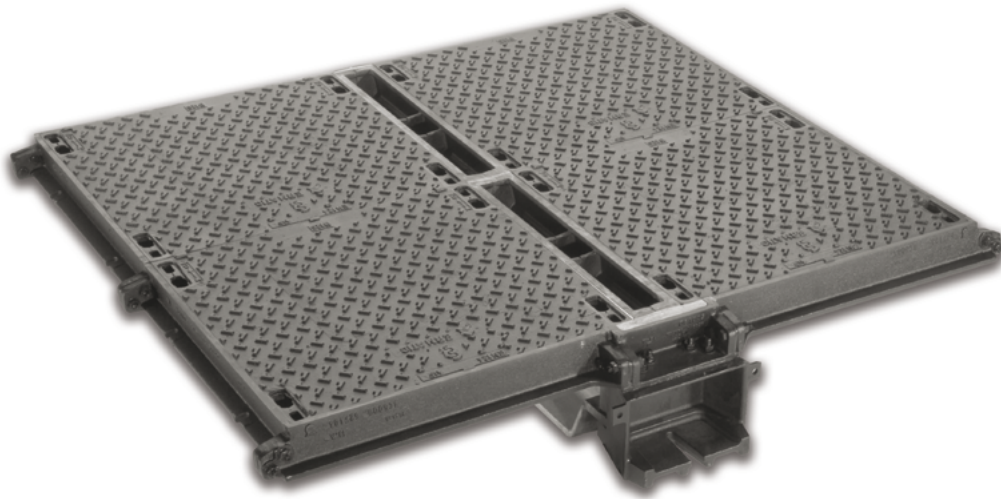

Multiple covers with removable beams recessed for concrete infill C250



Pavior infill cover

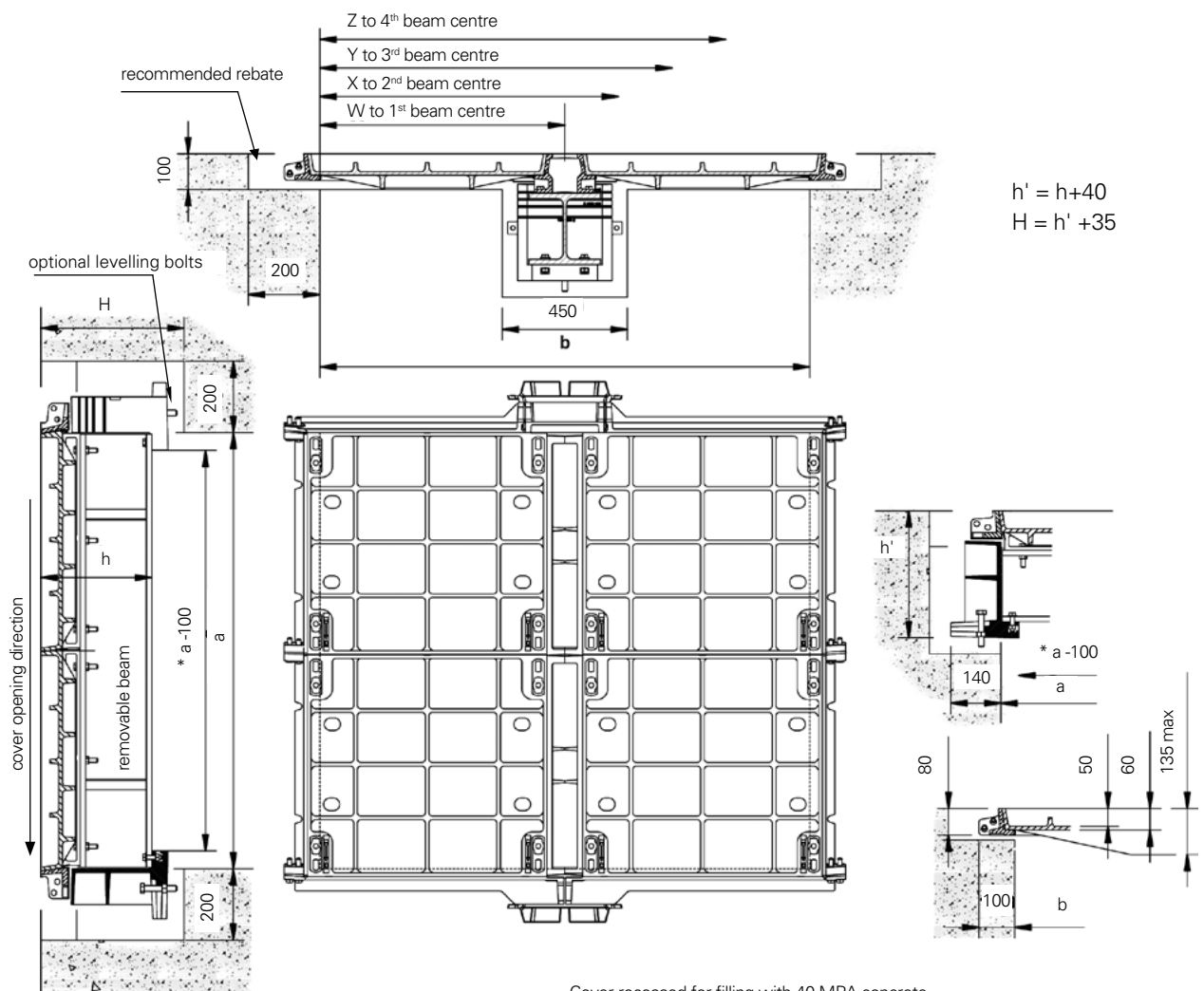

Dimensions in mm

Cover recessed for filling with 40 MPA concrete
 See technical file on p.D8

Multiple covers with removable beams: solid top anti-slip surface C250

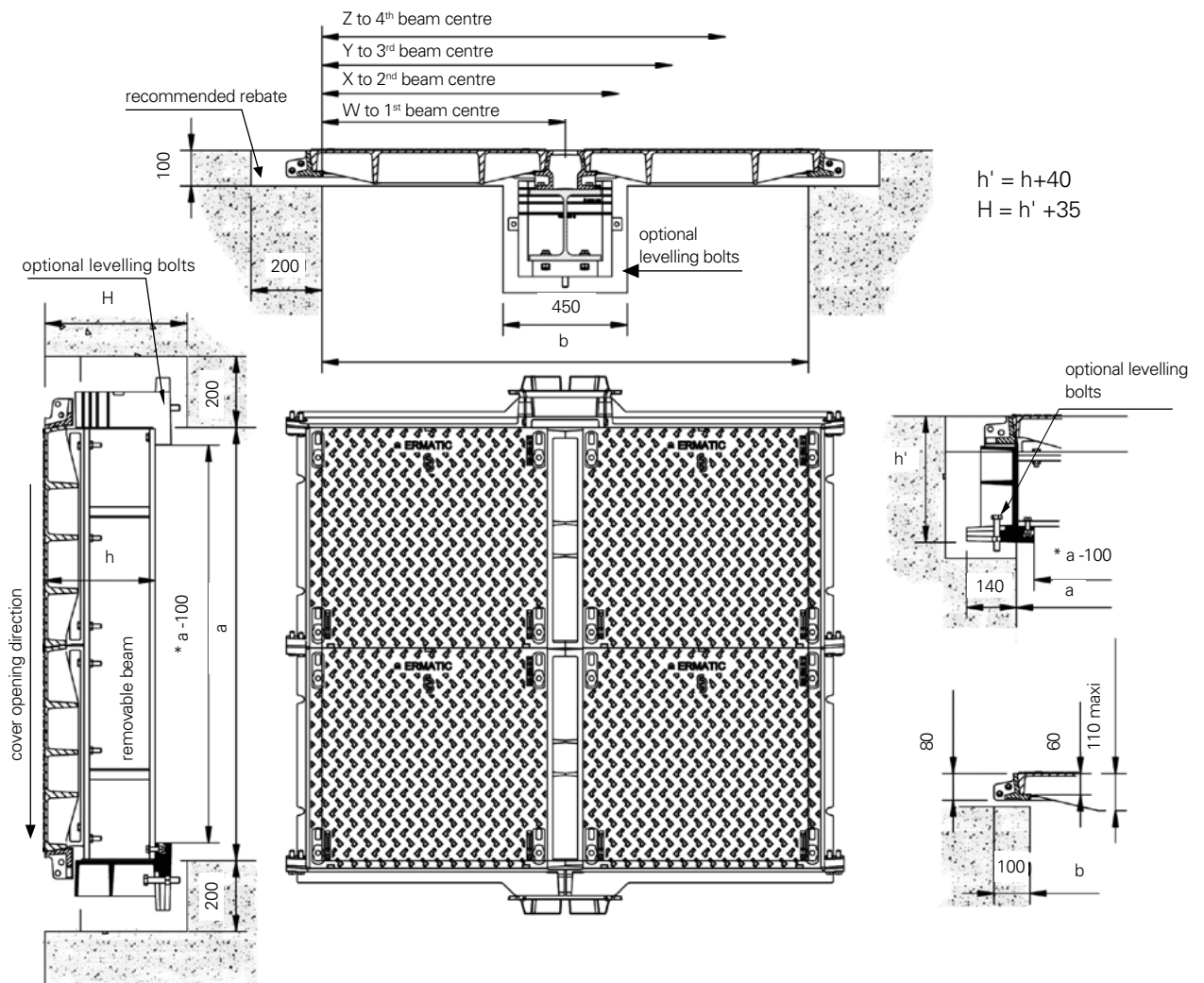

Dimensions in mm

Solid top anti-slip surface

Multiple covers with removable beams recessed for concrete infill D400

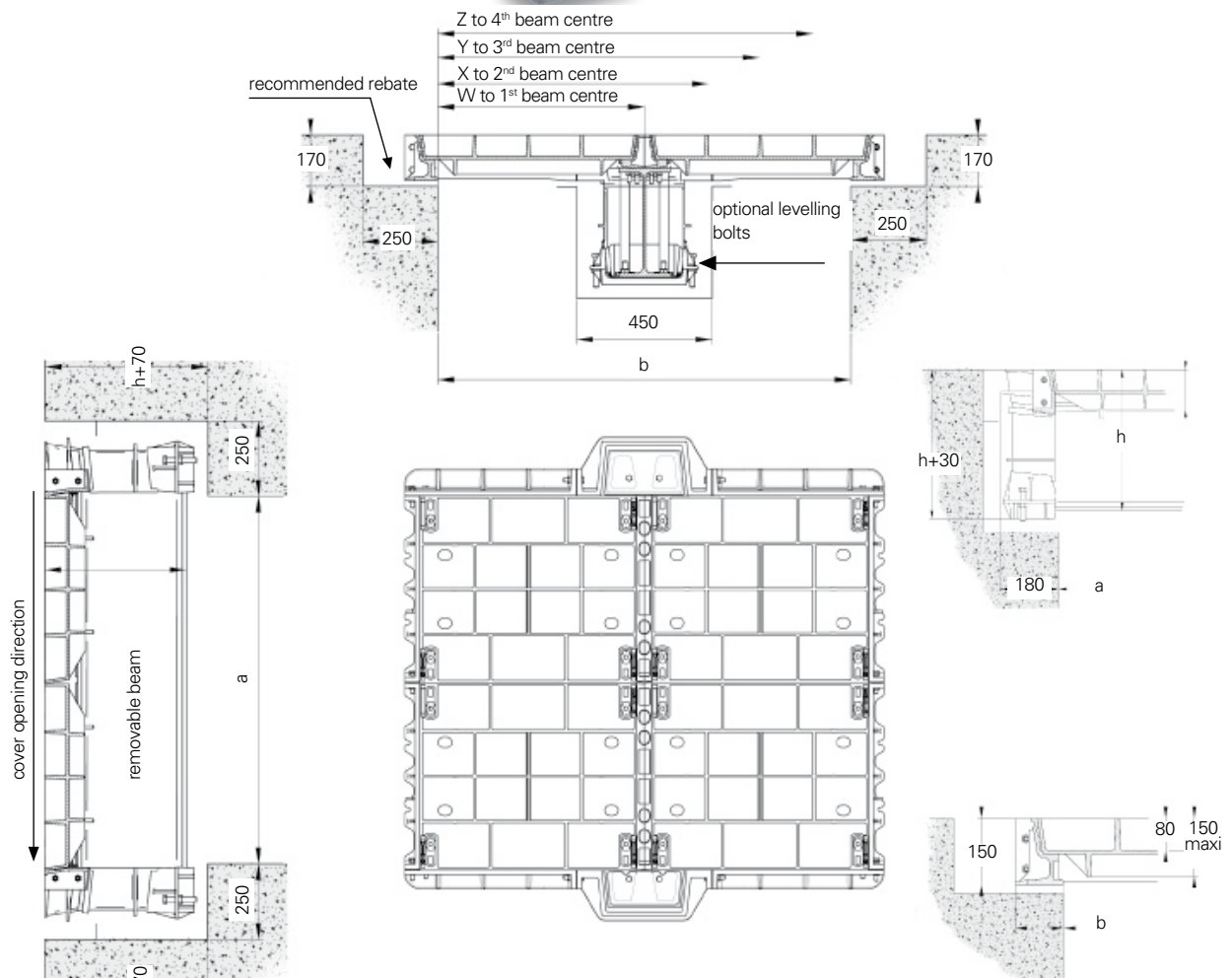
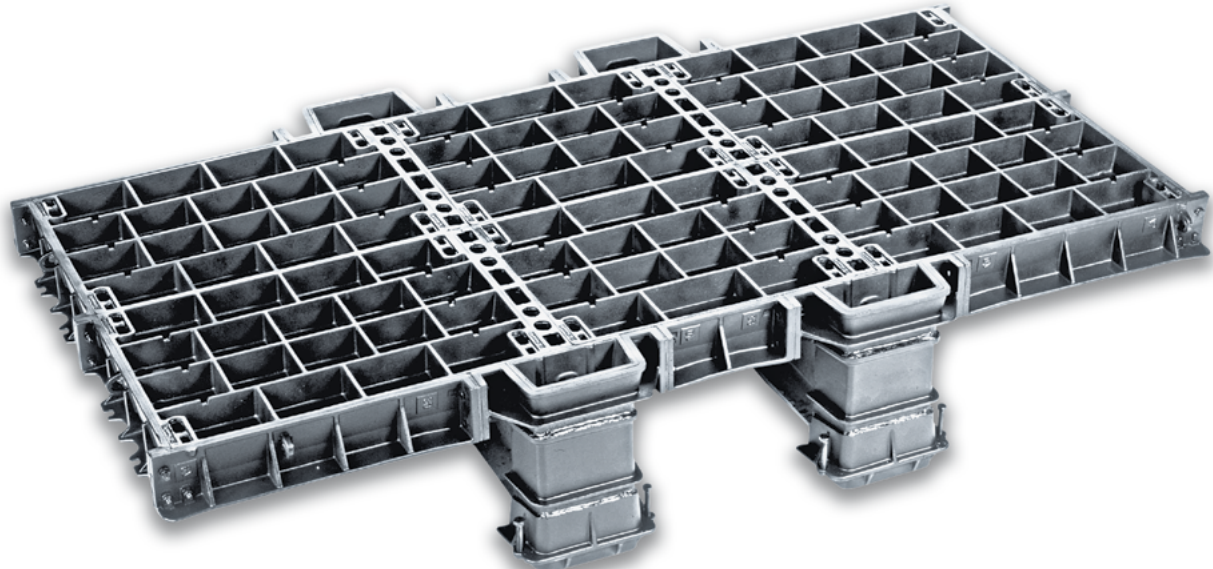

Dimensions in mm

Cover recessed for filling with 40 MPA concrete
See technical file on p.D8.

Multiple covers with removable beams: solid top anti-slip surface D400

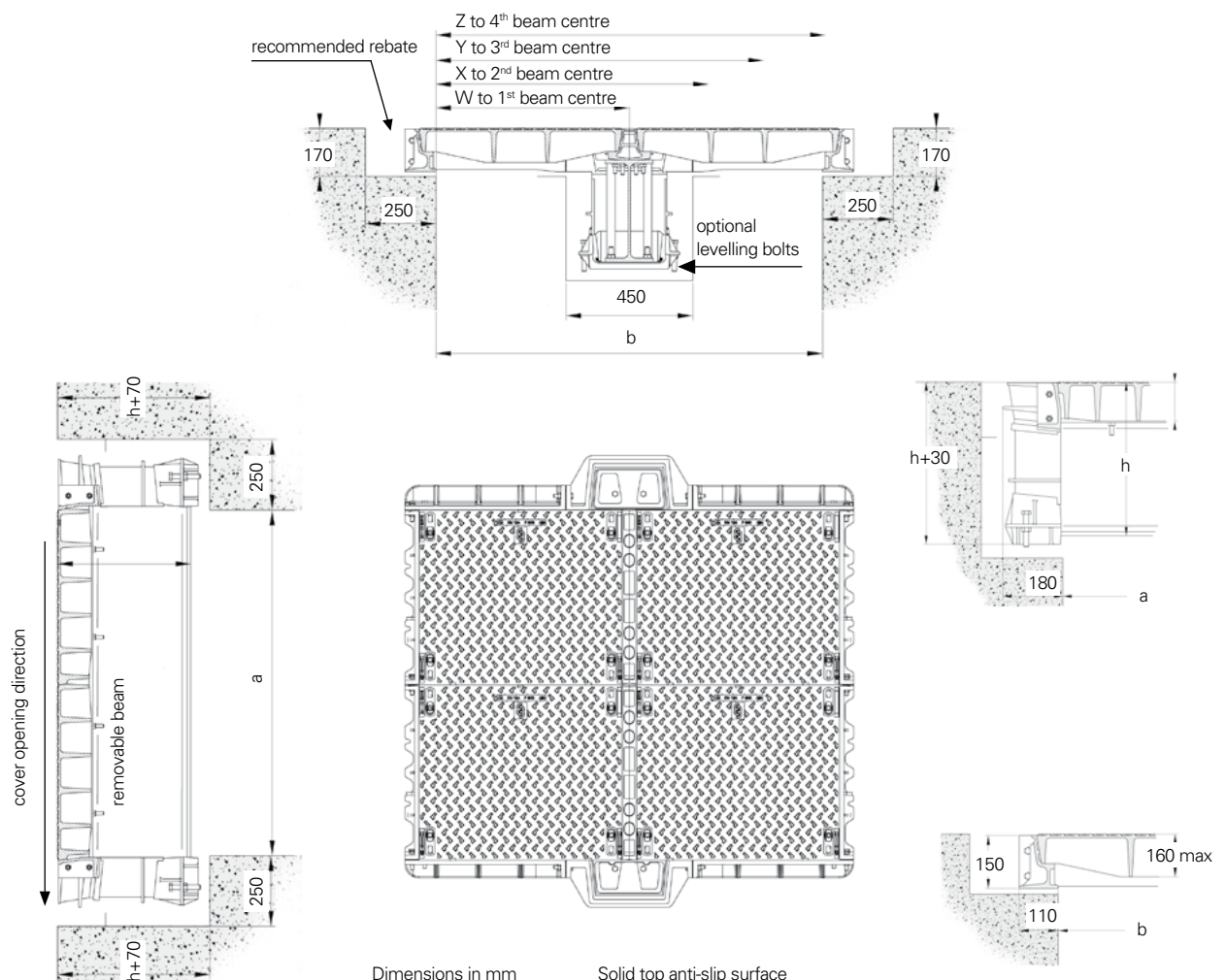
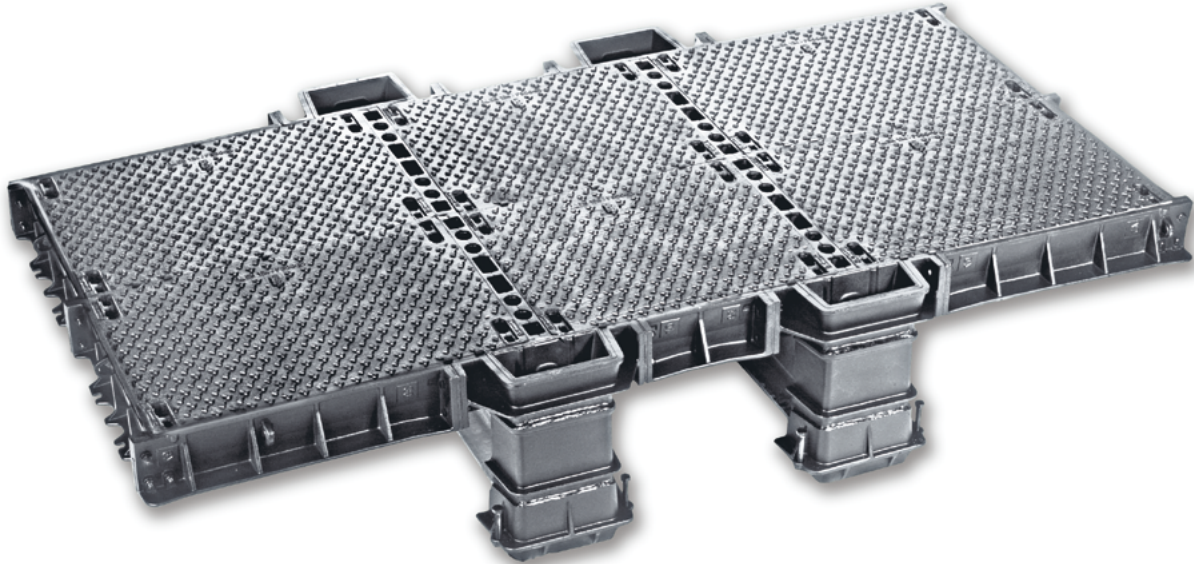

Multiple covers with removable beams: solid top anti-slip surface D400

Reference: **ER5S** (a x b) in cm

Standard clear opening dimensions a x b (in cm) - For other clear opening dimensions, please enquire

a \ b	clear opening cm	2 covers 1 beam					3 covers 2 beams					4 covers 3 beams					5 covers 4 beams					Removable beam used mm									
		137	152	167	182	197	214	229	244	259	274	289	304	291	306	321	336	351	366	381	396		411	368	383	398	413	428	443	458	473
2 covers	122	[Grid]																				IPE360 (h = 470)									
	137	[Grid]																													
	152	[Grid]																													
	167	[Grid]																													
	182	[Grid]																													
3 covers	184	[Grid]																				IPE400 (h = 510)									
	199	[Grid]																													
	214	[Grid]																													
	229	[Grid]																													
	244	[Grid]																													
	259	[Grid]																													
4 covers	246	[Grid]																				2910 IPE400 (h = 510)									
	261	[Grid]																													
	276	[Grid]																													
	291	[Grid]																													
	306	[Grid]																													
	321	[Grid]																													
	336	[Grid]																													
351	[Grid]																														
366	[Grid]																														
Beam centres (see opposite page)		Overall dimensions of cover (a + 360mm) x (b + 220mm) x (beam box height = h + 30 mm)																													

Clear opening in cm		137	152	167	182	197	214	229	244	259	274	289	304	291	306	321	336	351	366	381	396	411	368	383	398	413	428	443	458	473	488	503	518	
Beam centres (mm)	W	885	885	835	835	985	1465	885	885	835	835	985	985	2225	1465	885	885	835	835	885	985	985	2995	2225	1465	885	885	835	835	985	985			
	X	To 2nd beam centre					1465	1605	1605	1765	1905	1905	2055	2375	1465	885	2625	1605	835	2675	1765	835	2825	1765	835	2975	1905	835	2975	1905	985	3125	2065	985
	Y	To 3rd beam centre					1605	1605	1765	1905	1905	2055	2625	1605	835	2675	1765	835	2825	1765	835	2975	1905	985	3125	2065	985							
	Z	To 4th beam centre					1765	1905	1905	2055	2675	1765	835	2825	1765	835	2975	1905	985	3125	2065	985												

Area of installation

- Carriageways of roads (including pedestrian streets), hard shoulders and parking areas for all types of road vehicles. Group 4 and lower as per EN124

Specification

- ERMATIC D400 multiple access covers with removable beams
- Solid top cover with anti-slip surface
- Clear opening (a x b) in mm **reference ER5S** (a x b) in cm
- Machined horizontal and vertical contact faces
- Ductile cast iron according to ISO 1083 and EN 1563
- Galvanised mild steel beams
- Quality assurance by third party certification to ISO 9001.

Locking

- By 4 stainless steel bolts
- Standard locking (VCHC)

Options

- Level adjusting bolts (see detail on page 10)
- Security locking (VOTC)
- Hinged and assisted opening by gas strut (see details page 12)
- Safety grids (see detail on pages 144-145)

Handling

- Pair of EM keys (weight 8 kg per pair) (see detail on page 13)
- See details on handling operation on technical file.

Technical file

- Installation recommendations - Rebate preparation
- Installation and shuttering - Operation of covers
- Maintenance - Full technical specification

Options

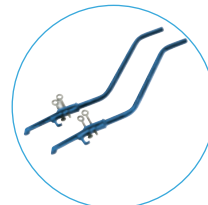

Handling key

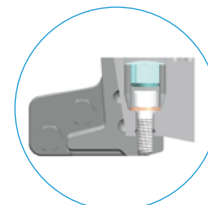

OTC locking

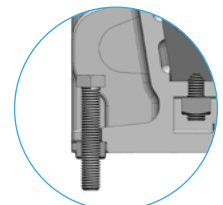

Levelling bolts



Safety grids

Multiple covers with removable beams recessed for concrete infill E600

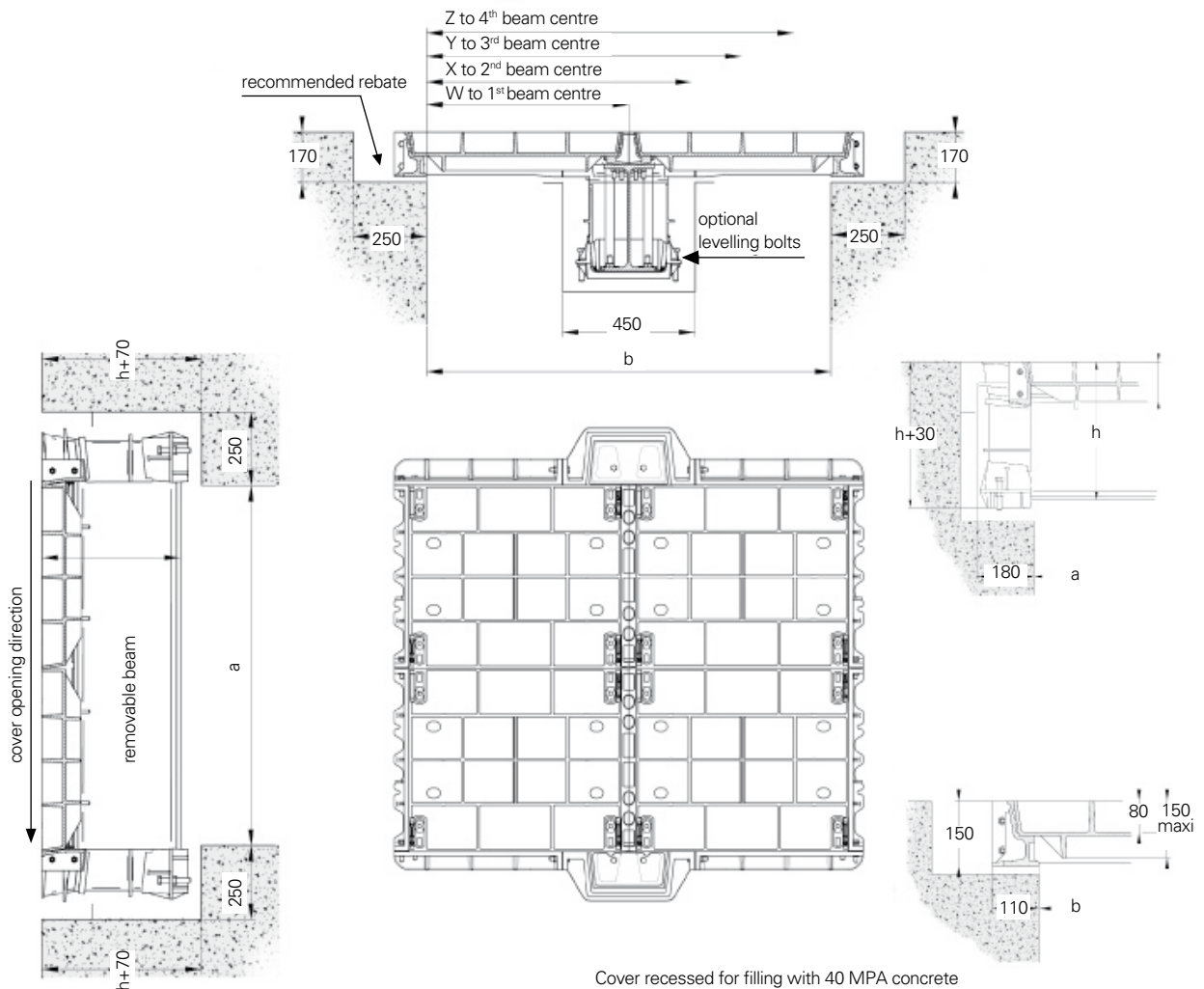
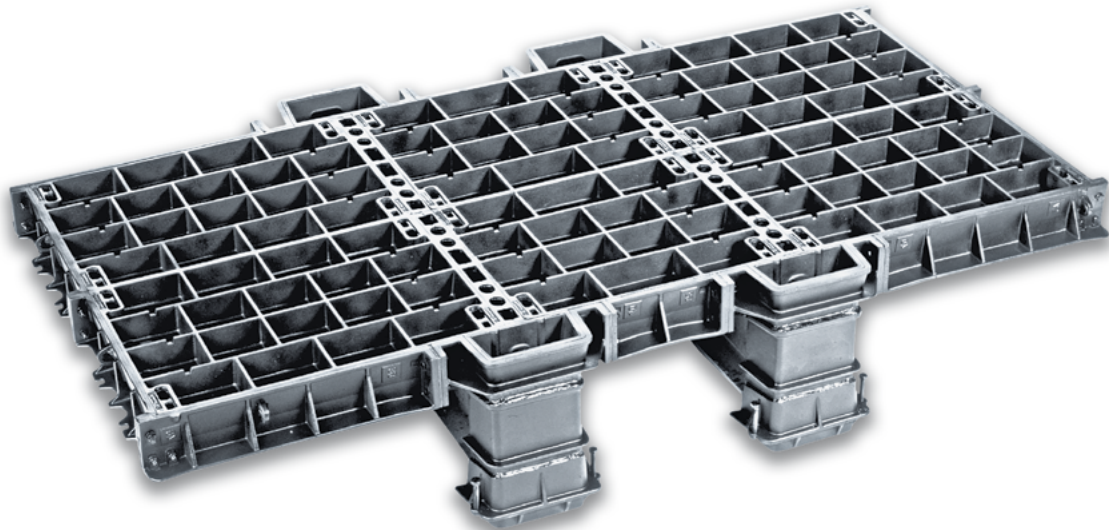

Multiple covers with removable beams: solid top anti-slip surface E600

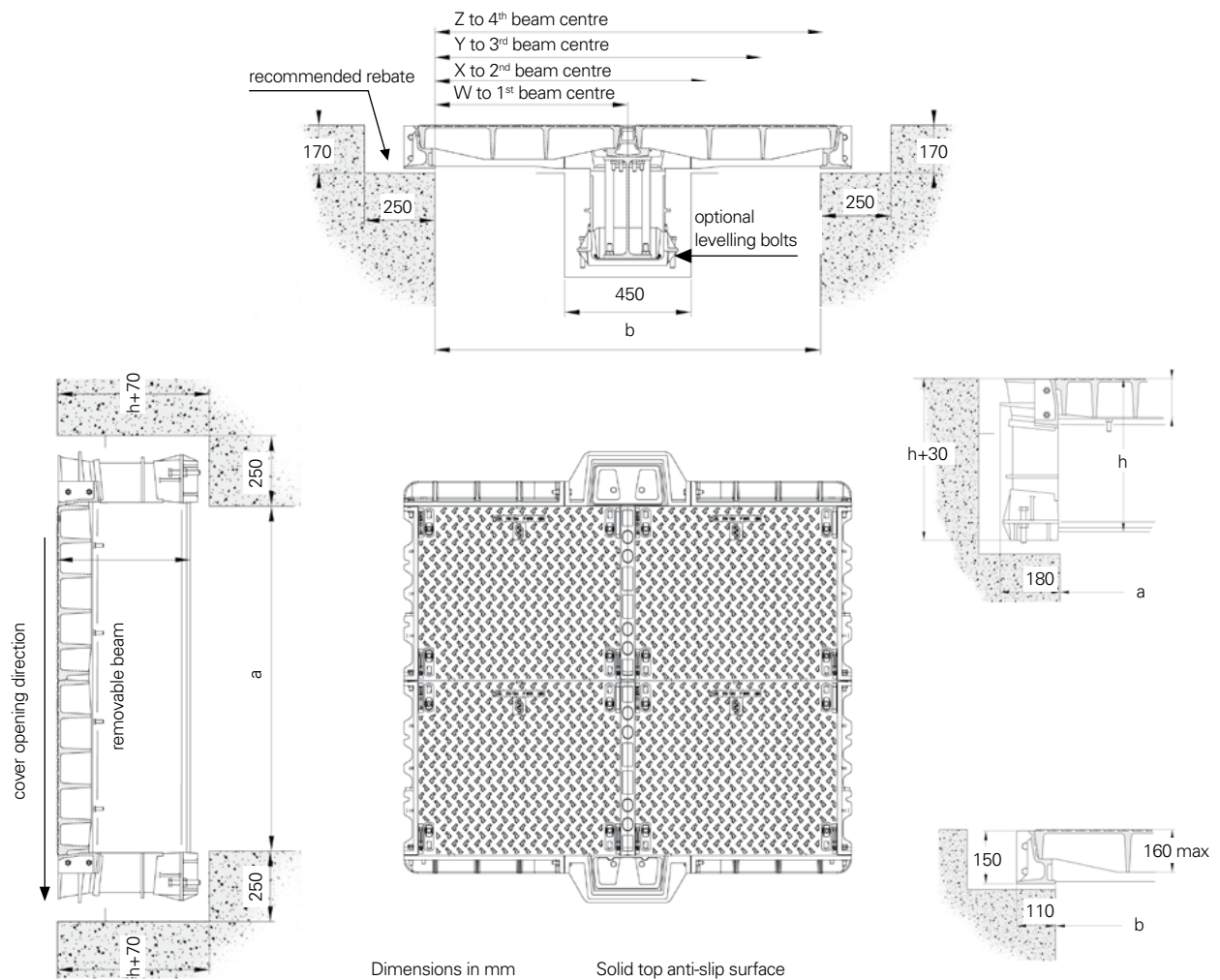
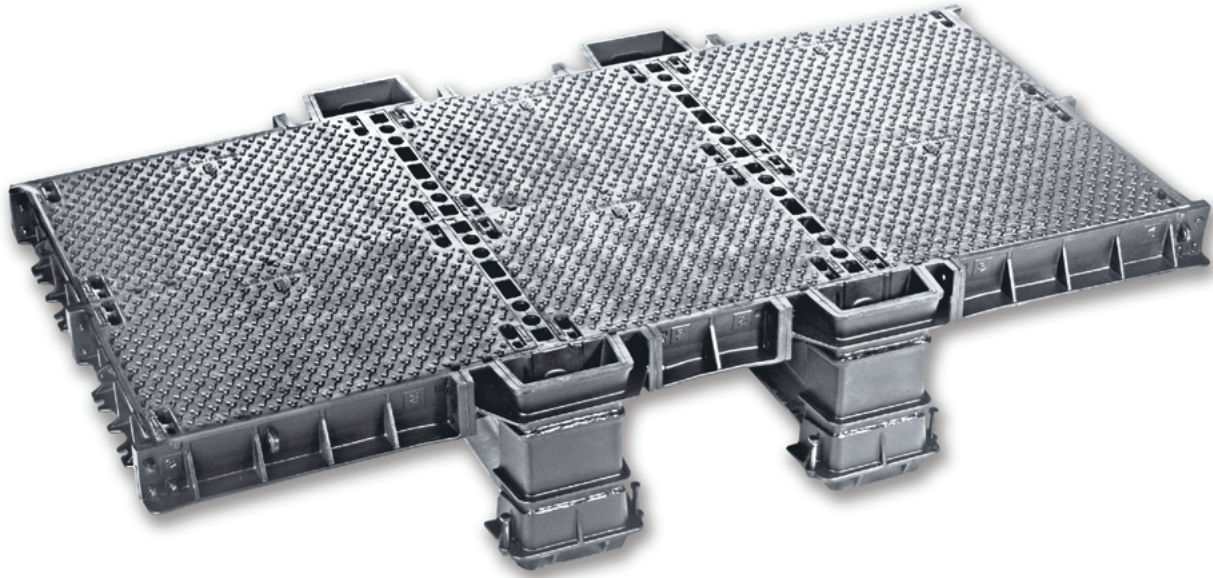

Multiple covers with removable beams recessed for concrete infill F900

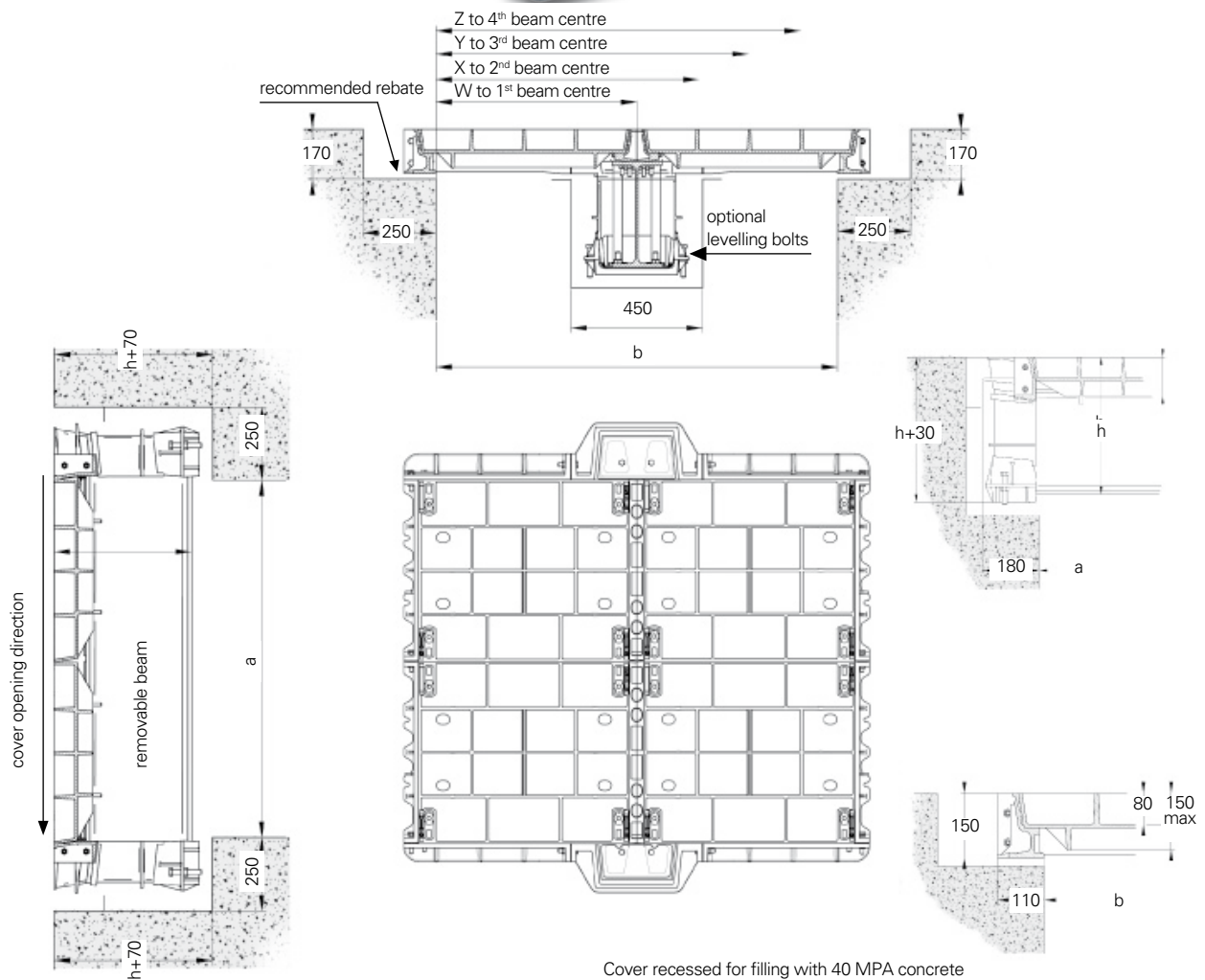
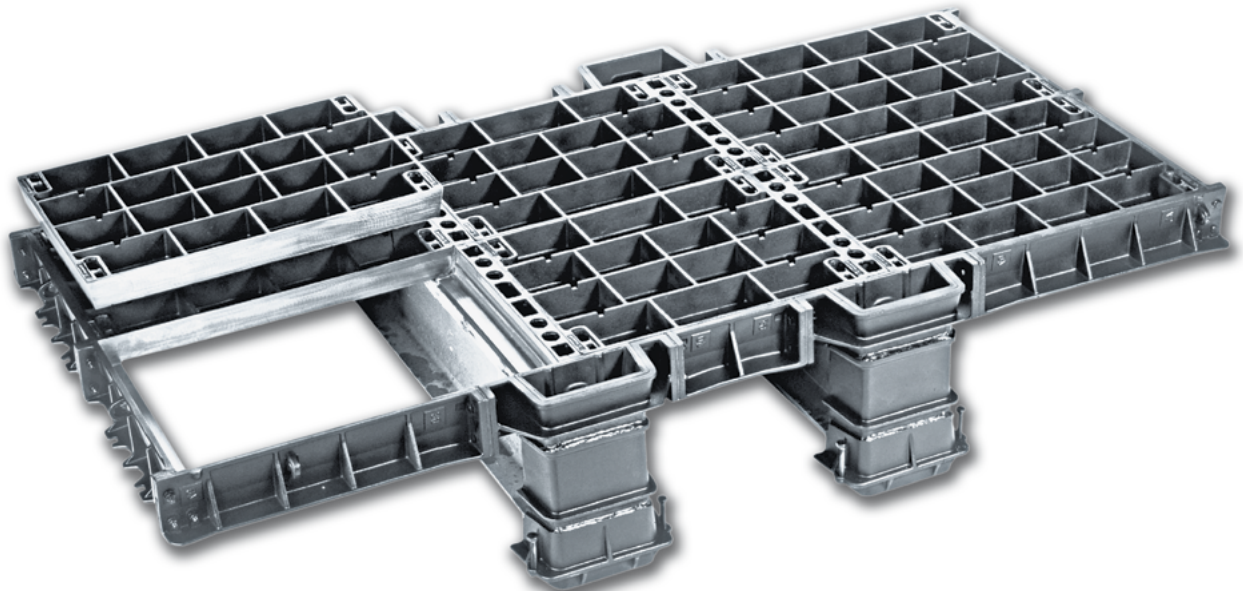

Multiple covers with removable beams: solid top anti-slip surface F900

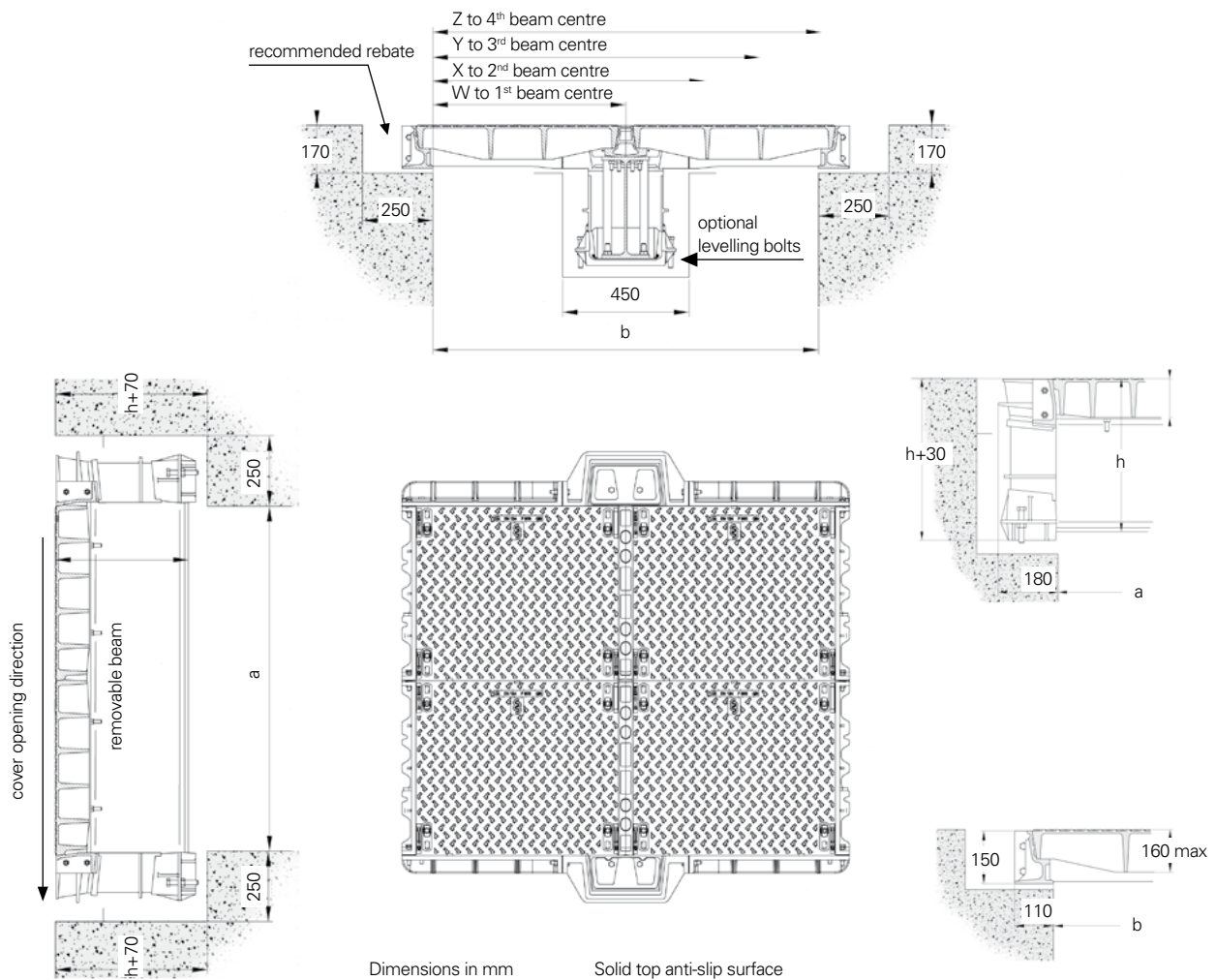
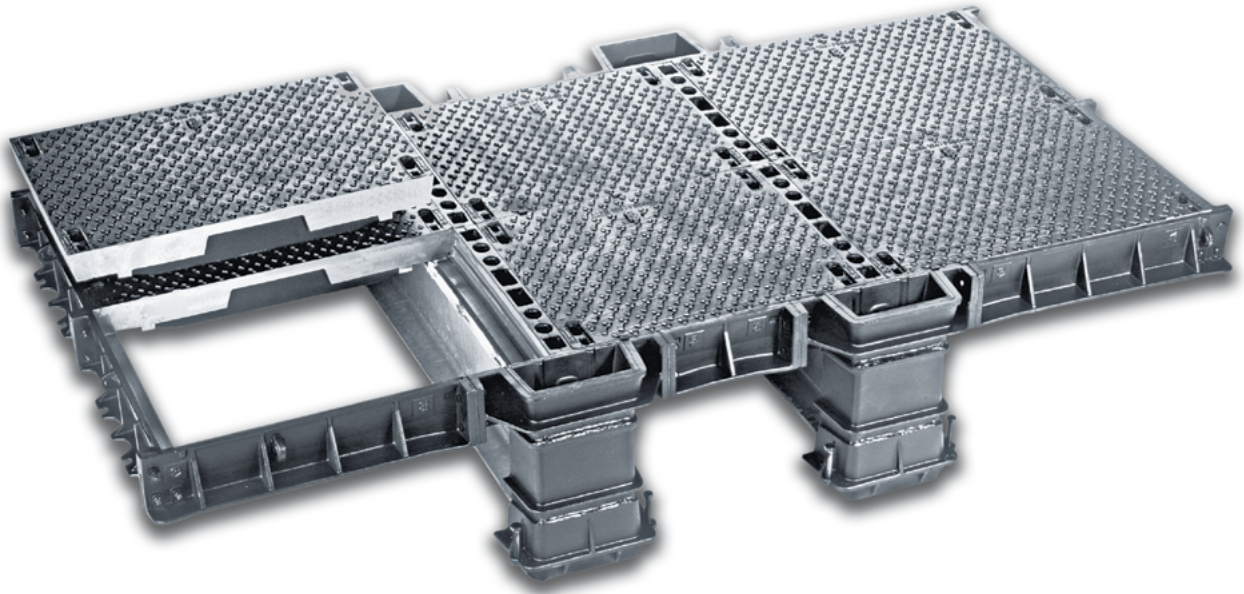

Notes

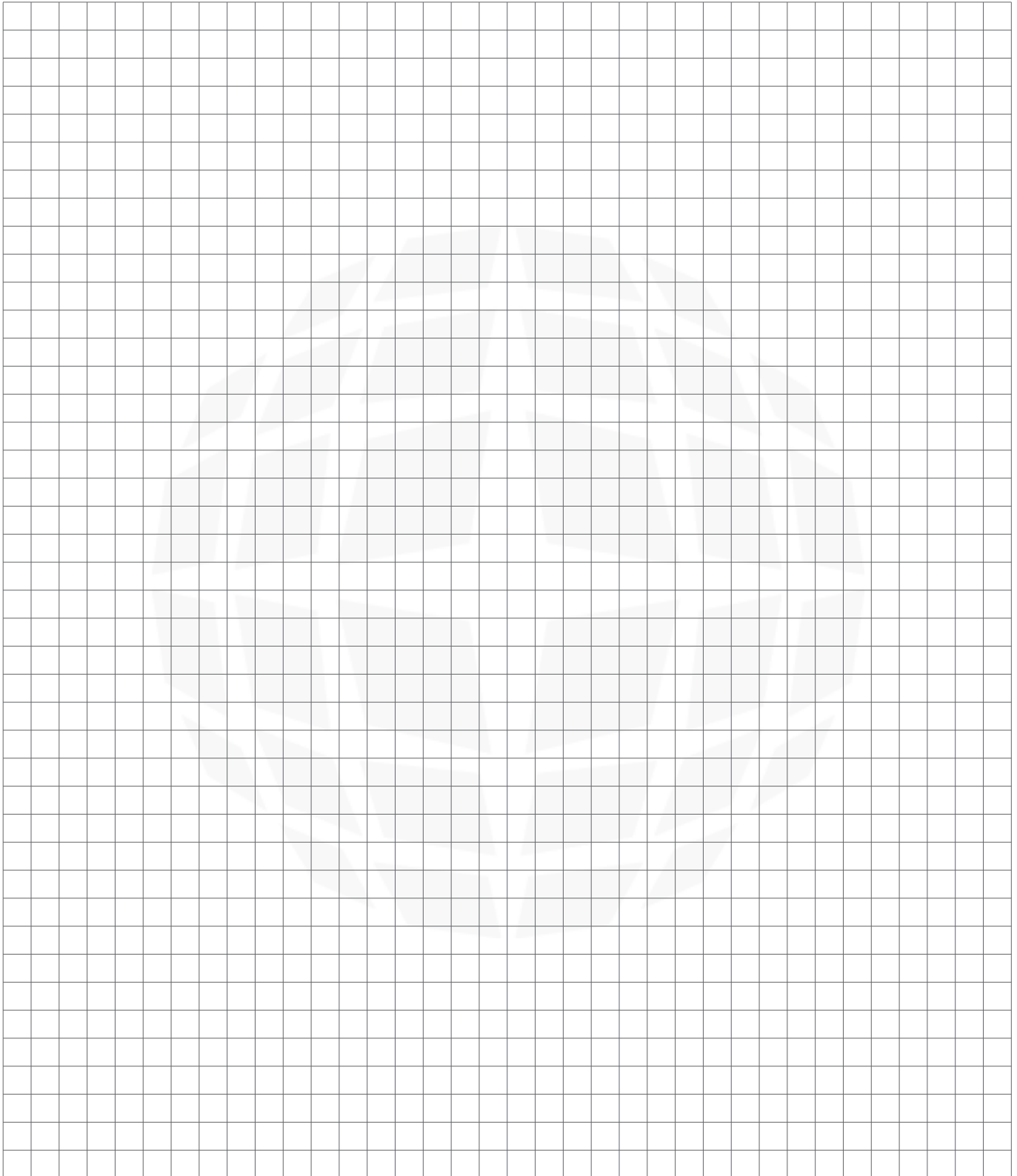

Ermatic® range Technical file



- 88 Technical assistance with installations
- 90 Installation recommendations
- 94 Recommendations for the concrete infill of covers
- 95 Operation of Ermatic covers
- 96 Specification details for bills of quantities

ERMATIC® range

Technical assistance with installations

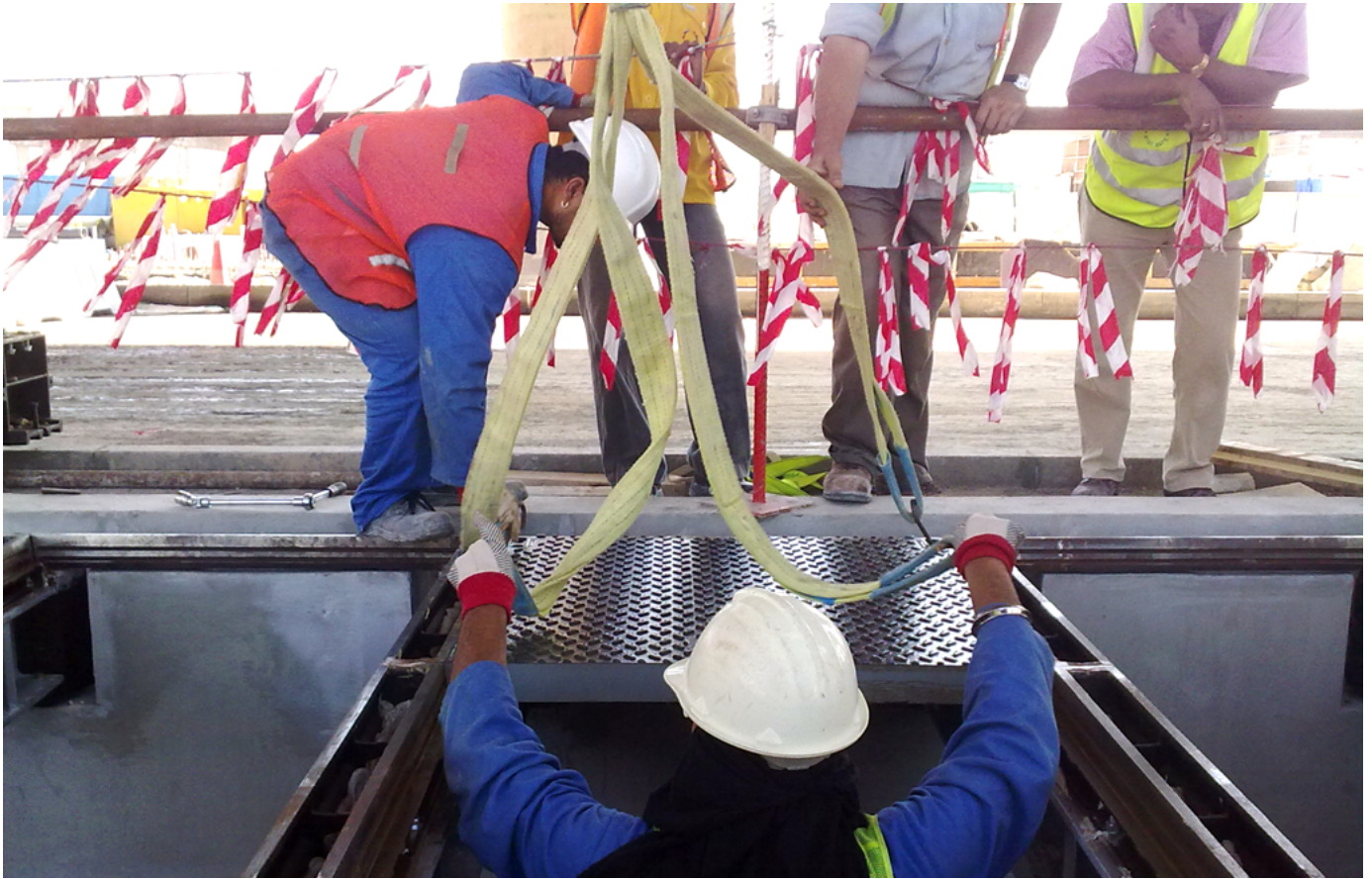
**Technical assistance with installations**

For the installation of access covers and frames, EJ can provide, upon request, various levels of technical assistance.

Objective of the site assistance

- Assist the contractor in the installation and grouting of the covers and frames.
- Help maintain the right factory controlled tolerances.
- Assist the contractor and end-user with practical operation, maintenance and handling instructions.

ERMATIC® range

Technical assistance with installations

There is no standard or definitive guide to the installation of access covers and frames. These recommendations are designed to assist in the installation of ERMATIC covers in general situations that present no particular technical difficulties. All frames and beam wallboxes must be adequately, solidly and continuously supported to a degree sufficient for the designed load conditions in each particular case. ERMATIC covers and frames are made from machined elements, assembled to strict tolerances.

The frames are assembled around their respective covers in order to provide a continuous peripheral contact between the seatings and side contact faces. When correctly installed, the tight manufacturing controlled tolerances will be maintained, thus ensuring cover stability and non-rock and will prevent the ingress of debris and running rainwater (under normal rainwater conditions). In order to protect the machined surfaces from contamination with silt and mud, cover and frame components must be positioned or stored on clean surfaces.

1 Rabbet

- For all devices, prepare a peripheral anchor rebate according to the proposed dimensions.
- For **multiple beams** and **special gutters** with connections and returns : provide, in addition, the specific reservations offered on the plans provided during the study or delivery.

hauteur de cadre : 80 mm

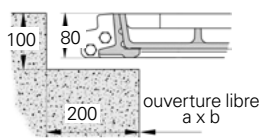

hauteur de cadre : 125 mm

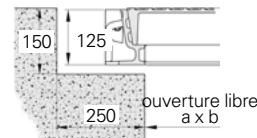

hauteur de cadre : 150 mm

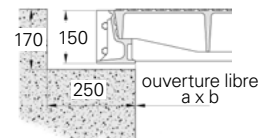

2 at 2.3 Laying and formwork

- See following pages

3 Scellement

- **Important : The covers must be in place in the frame (and locked if applicable) during the sealing operation and until the concrete is completely set.**
- Stuff the concrete under the frame until refusal.
- Fill the rabbet with successive layers.
- Do not forget to perform a stitching of the

concrete.

- If the time required to set a standard concrete can not be ensured in accordance with good practice due to the time required for commissioning, the use of a rapid setting shrink resistant sealant type EMACO T926 Gravel or similar is recommended.

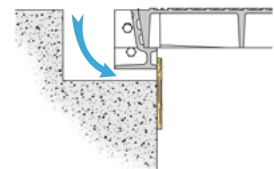

coffrage

4 Filling Lids : Filling Series

- See detailed filling instructions p.D8

5 Finishing and commissioning ·

- Wait for the complete setting of the concrete. Remove the covers to execute the finishing mortar.
- Clean and grease all contact faces of the frame and covers each time the cover is handled. The use of a type ELF CARDREXA GEP2 grease is recommended.

ERMATIC® range

Installation recommendations: 1/2/3 part covers and frames

2 Installation and shuttering

- Center the device correctly in its rabbet.
- In order to facilitate the upgrade of the product in relation to the road level, we strongly recommend the use of our optional upgrade screw kit. If not, use shims, position them under each frame joint and add them until you reach the desired level.
- Remove the locking bolts (if applicable) and remove the cover from the frame

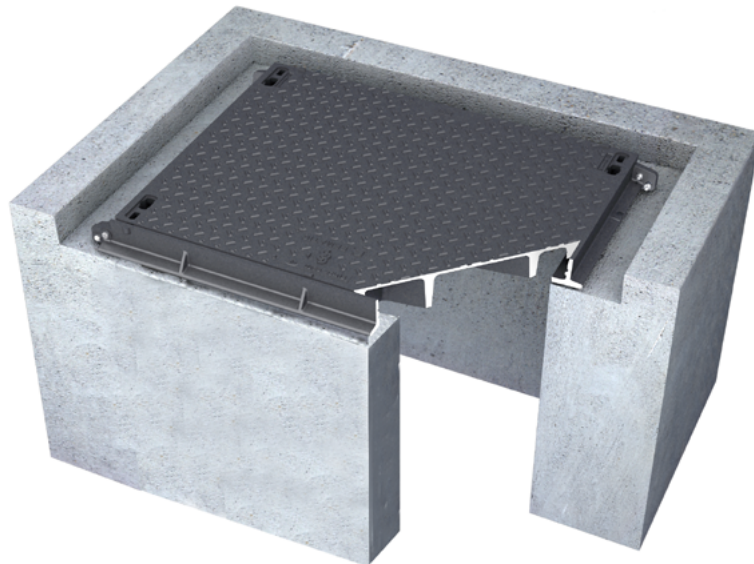
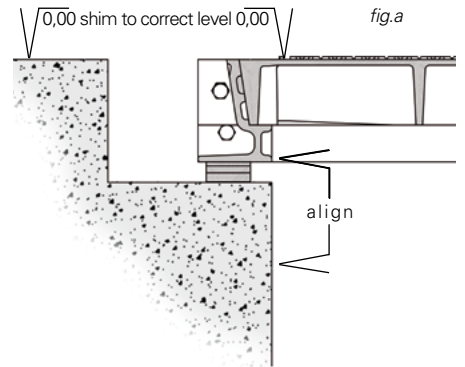

2.1

- **Provide** the space between the base of the frame and the concrete of the room.
- **Check** that the machined contact faces of the frame and covers are free of dust and mud, if necessary remove these impurities.

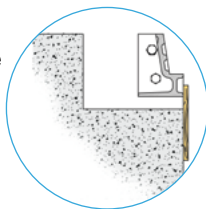

2.2

- **Place** the covers in the frame referring to the existing marks (if applicable, see marking plan).
- **Check** their stability and the continuity of the metal-to-metal peripheral contact between the frame and the cover, if necessary correct the setting and put clamps.)
- **Screw in the locking screws** (if applicable) or installation screws (if applicable)

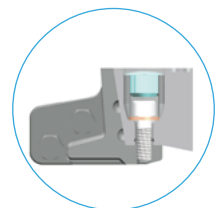
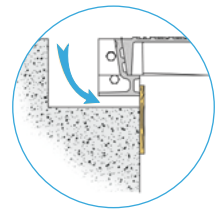

ERMATIC® range

Installation recommendations: duct covers and frames

2 Installation and shuttering

- Duct covers and frames are usually shipped in "pre-assembled" modules (or elements).
- Position the first module **1** in the rebate in accordance with the assembly drawing.
Do not cut the metal bands connecting the covers with the frames.
- Center the duct assembly within the clear opening of the duct chamber (*fig.a*)
In order to level the product to the correct load level, we strongly recommend the use of our optional level adjusting bolt kit.
Otherwise, use metal shims; position those under each frame joint and add until you reach the desired level. (*fig. a*)
- Position the second module **2** in the rebate.
- Repeat the above section on centering and level adjusting.
- Bolt the second module to the first one **3**
- Complete the installation by repeating the previous instructions and proceed element by element.
- Finish the installation with the generic Ermatic recommendations, elements by elements, after removal of metal bands and covers.

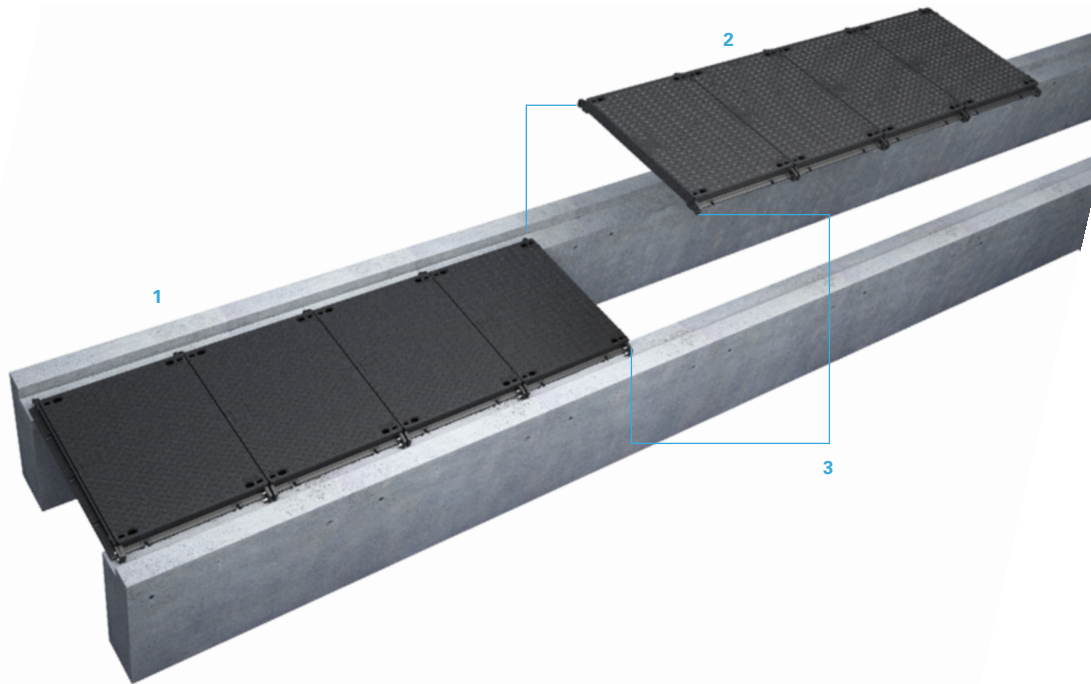

2.2

- **Mask** the keyways with the plastic plugs.
And, if applicable, fit the oval plastic plugs in the bottom of the covers (recessed covers only)



ERMATIC® range

Installation recommendations: covers with removable beams

2 Installation and shuttering

- Start the assembly from one end of the chamber in accordance with the assembly drawing.
- Install and correctly center the 1st beam (still bolted to the wallboxes) within the rebate **1**.
- Correctly level the beam by adjusting the beam leveling bolts **2**.
- Install and bolt to the wallbox, the adjacent end bars **3**.
- Bolt the side frame bars (parallel to the beam) to the end bars **4**.
- Check to ensure that the frame assembly is centered within the chamber (fig.a).
- Shim to the correct level, (fig a) underneath each frame corner and underneath each frame joint using metal (or similar) packers.
- Complete (if necessary) the installation of the next beams and frame elements by repeating the following 3 operations :
 - Install and center correctly within the rebate, the 2nd, 3rd beam etc. (still bolted to the wallboxes) **5**.
 - Correctly level the beam by adjusting the beam leveling bolts **2**.
 - Bolt to the corresponding end bars.
 - Install by bolting the 2 new end bars **6**.
 - Finish and complete the construction of the frame by bolting to the end bars, the side frame bars (parallel to the beam) **7**.

B 125 to C 250 beam detail



D400 to F900 beam detail



2.1

- **Check** that the machined contact faces the frame and covers are free dust and mud, if necessary remove these impurities.
- **Position the lids** in their respective frames. If applicable, consult the tracking plan.
- **Check** that the covers do not tilt and that they are in continuous contact with the frame. If necessary, adjust the shims and use pliers to obtain a satisfactory result.

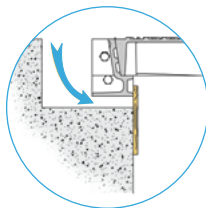

2.2

- **Retract** the lids on one side so to allow the next step (formwork).

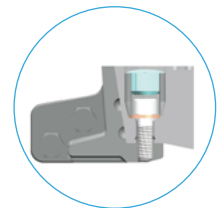

2.3

- **Tighten** the locking screws or installation screws (if applicable), after greasing the machined surfaces (frame, cover).

ERMATIC® range

Installation recommendations: covers with removable beams

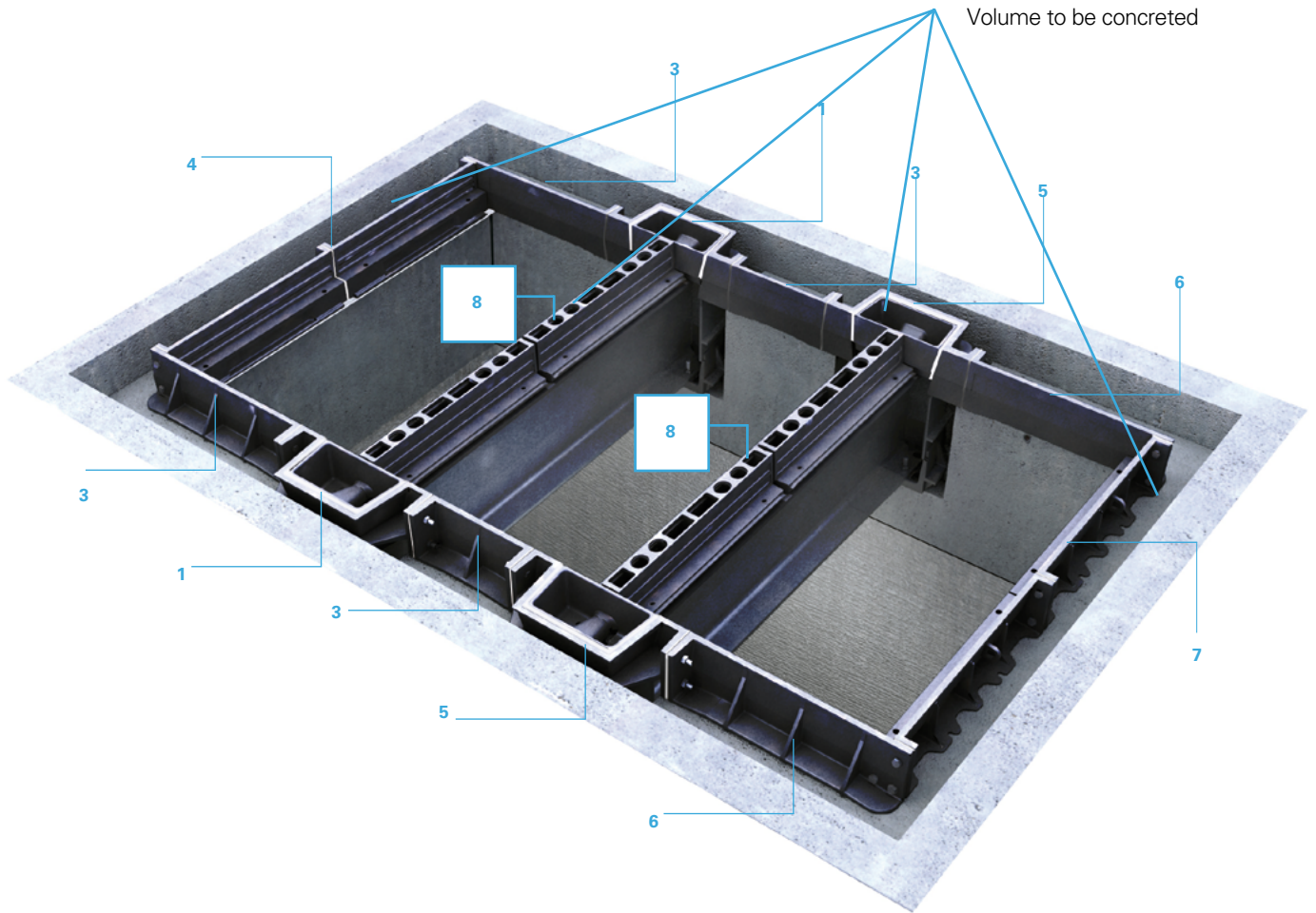

2.4

- **Seal** the device and fill the beam boxes together with the cells above the beams (5 / 8)

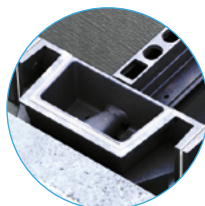
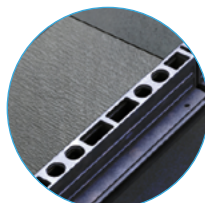

2.5

- **Seal** key holes with plastic plugs. And, if applicable, place the oblong plastic plugs in the bottom of the lids (for filling lids only).



ERMATIC® range

Recommendations for the concrete infill of covers

In this document, the recommendations are given as guidelines only and reflect the latest research available to us; nevertheless, we cannot accept any liability from their application. The description and choice of materials must be appropriate to the specific conditions of each application (conditions of use and installation). The concrete infill is part of the complete product, so a particular care should be taken regarding its manufacture and application.

The expected quality shall be the same as required for construction work concrete with high mechanical performances (> 40 Mpa after 28 days on a test cylinder of 150 x 300 mm).

Therefore, its composition should be analysed to achieve the highest possible performance with regards to the specific concreting conditions of your application.

1 Support

The recesses must be clean, exempt from any trace of products such as grease, oil, sand, dust Any non adhesive particles must be removed.

2 Composition of the concrete

As an indication, the typical concrete mix design may be characterised by :

Cement

- a cement CEM I or II 52,2 proportion near to 450 kg/m³.
- its chemical composition shall be adapted to the area of installation, e.g. cement type PM (marine and chloride environments) for works exposed to a sea atmosphere.

Granules

- A G/S (gravel / sand) ratio < 1,5.
- The diameter of the biggest granule shall be < 12,5 mm.
- The required acceptance criteria must be those of construction work concrete, of which the characterised resistance after 28 days is over 40 Mpa.
- If the granule(s) is (are) classified as potentially reactive (PR), then the total rate of active alkalines in the concrete must be limited to a maximum of 3 kg/m³ (this requirement will often lead to the choice of low alkali cement (< 0,6 %).

Water

- The ratio of water / cement (W/C) must be smaller than 0,4.
- The water used must be drinking water.

Admixtures

In order to reduce the W/C ratio and in respect to the maintenance of the rheology for the time necessary to fill the several covers with concrete of the same batch, admixtures must be certified to the NF Mark or complying with national standards (BS/ASTM/AFNOR ...), such as plasticisers, High Range Water Reducers, set retarding admixtures.

The dosage of these products (expressed as a percentage of the

cement weight) must be kept inside the limits defined by the supplier or in the product technical information sheet, in order to avoid detrimental effects on the other properties of concrete.

3 Installation

Temperature of the concrete at the time of delivery : between 10 and 32°C.

Temperature of the concrete appliances:

- Except for special circumstances, concreting must not be carried out on appliances:
- which temperature is < 5°C, or
- which temperature varies by more than 10°C from the temperature of the concrete.

Vibrating :

- After filling, the concrete must be vibrated, preferably on a vibration table. In case of vibration needles (pervibrators), the picking must be done regularly on the cover surface while avoiding any contact with the cast iron.
- The vibration should obtain a maximum compacity and a perfect filling of the recesses, without causing any segregation.

Finishing :

- The filling must be carried out without excess
- A level surface must be assured and checked by means of a straight-edge. The maximum fluctuation allowed is 3 mm.
- The obtained surface must be equivalent to that of the carriageway level.

4 Curing of concrete

Immediately after manufacturing and cuffing the free surface, the latter must be protected from free circulation of air and from any evaporation / desiccation.

This can be achieved :

- Either by storing the covers in a place where the atmosphere has a humidity ratio near to 95 %.
- Either by pulverising it with a curing compound of which the efficiency has been proved (re. list of approval and reference for the execution of carriageways or airfield pavements in concrete).

In case of concreting at low temperatures, every precaution must be taken to make sure that the temperature of the concrete remains above 5°C.

5 Release

The works must only be released when the resistance of the concrete infill will have attained 40MPa.

Technical assistance · Other information

If you require any further information, please contact your nearest technical centre.

ERMATIC® range

Operation of Ermatic® covers

Opening direction

- Covers can only be opened in one direction, as indicated by an arrow as shown below.
- Remove the plastic keyhole caps.

Cover handling

- To handle the covers, use a pair of EM keys with the blocking and jacking bolts.

Opening

- Note: the covers only open in one direction; as shown by the arrow on figure a.
- Clean the keyways with a screw driver.
- Completely insert the EM keys.
- Tighten by hand the blocking bolt **(A)** to lock the key in position. Do not over tighten the blocking bolt, as this will damage the key.
- Tighten the jacking bolt **(B)** to put tension on the cover/frame joint.
- Lift the one edge of the cover from the frame.
- Pull the cover from the frame along the greased machined seatings.

Maintenance

- **Before delivery**, all the machined faces of the 1/2/3 part cover and frame are greased (duct covers and beamed multiples are greased by the contractor on site). Covers are partially painted with water soluble black paint.
- **In service**, after each cover opening and when performance and environmental requirement demand, it is necessary to clean and apply an appropriate grease (see section on grease) to the machined faces of the cover and frame.

Covers with locking bolts

- Note the position of the covers in the frame, these are not interchangeable.
- Unscrew the locking bolts with :
 - For CHC: a six sided key. (size 10/12 or 14)
 - For OTC: a special OTC key.
- Note: the OTC bolt is a left hand thread.

Interchangeability of covers

- **1/2/3 part covers and frames not locked, class < D400:** the covers are interchangeable within the original frames.
- **1/2/3 part covers and frames locked, class ≥ à D400 Duct covers (< 3 covers long), beamed multiples covers:** the covers are not interchangeable. They have to be positioned precisely, in accordance with the marking system visibly stamped into each cover and frame at the production site.



Figure a

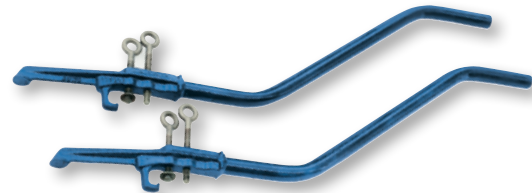

EM keys

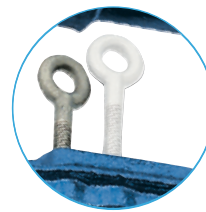

(A) blocking bolt

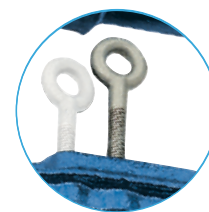

(B) jacking bolt

Closing

Before closing:

- Clean and grease the machined faces of the cover and frame.
- Unscrew the jacking bolt on the EM key so that it is not on the way during the operation. **(B)**
- Position the covers in place, respecting (if appropriate) the marking system visibly stamped into each cover and frame.
- Replace the plastic keyhole caps.

Characteristics of graphite grease :

- Resistance to loading and shock.
- Good adherence.
- Insoluble in water.
- Good resistance to extreme temperatures.

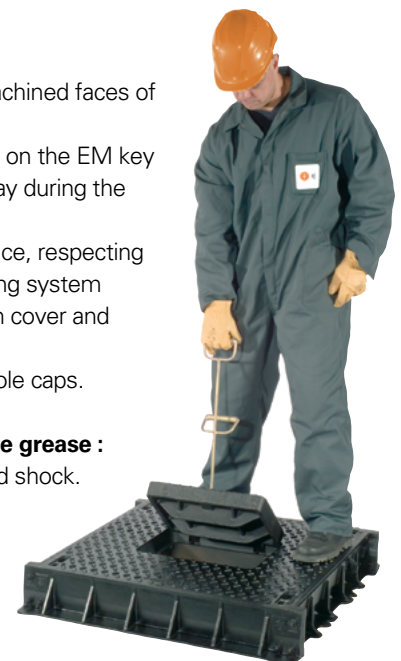

ERMATIC® range

Specification details for bills of quantities

Item	quantity	Description	unit price	total price
.....	<p>Ermatic covers and frames</p> <p>Reference : ER</p> <p>Clear opening dimensions</p> <p>(a x b in mm) :</p> <p>Mechanical Characteristics: Construction principles as per EN124: 1994 Class : (B 125, C 250, D 400, E 600, F 900) (F 900 covers when concreted for the recessed series)</p> <p>Beams: (only applicable to beamed multiple units) Conforming to the following French standards ERMATIC® B 125 : Loading 500 daN/m² ERMATIC® C 250 ; CCTG Chapter 61 clause II ERMATIC® D 400 ; CCTG Chapter 61 clause II ERMATIC® E 600 and F 900 : ADP and STBA On application: Eurocode 3 compliance</p> <p>Covers:</p> <p>·Type: (Recessed, solid top covers with anti-slip surface)</p> <p>·Locking: (standard locking VCHC or security locking VOTC)</p> <p>·OTC key for special security (Only when OTC is specified)</p> <p>Material:</p> <p>·Covers and frames: SG cast iron according to ISO 1083 and EN 1563</p> <p>·Beams and other steel components : Conforming to NF EN 10025/ NFA45255/201/201 (Only for beamed multiples)</p> <p>Cover stability: Assured by machining the seating contact faces of the cover and frame.</p> <p>Sealed against water and debris: By the interposition of a film of an appropriate grease on the contact faces of the cover and frame.</p> <p>Pair of EM Keys for handling: By sliding on the machined faces of the cover and frame easily using a pair of EM keys with blocking and jacking bolts.</p> <p>Painting:</p> <p>·Cast iron covers and frames : Painted with water soluble paint except machined surfaces and surfaces in contact with concrete Covers supplied disassembled: Machined surfaces coated with a protective film. Special high performance corrosion protection available on request.</p> <p>·Beams and other steel components : Steel components protected by hot-dip galvanizing to ISO 1461.</p> <p>Installation, concrete filling of recessed covers and operation: As per the manufacturer's recommendations.</p> <p>Technical assistance on site: Upon request from the manufacturer for large or complex covers.</p> <p>Quality assurance/Certificate of conformity (on application): System of quality assurance conforms with the requirements of ISO 9001 and ISO 14001 certified by third party.</p>

CT4B range



- 98** Introducing the CT4B range
- 102** 1/2/3 parts cover concrete infill
- 104** Continuous duct covers concrete infill
- 106** Multiple covers with removable beams concrete infill
- 108** Installation recommendations

CT4B range a new modular solution



The CT series, a new modular range, designed to meet the demands of the modern infrastructure.

With an increasing number of vehicles on the road today and an ever more complex and dense network of utilities in our expanding urban areas, accessing an underground utility asset through access covers has become a real challenge for network operators.

In addition, the sheer number of vehicles on the road, including a higher number of heavy goods vehicles, is putting the civil infrastructure and the manhole access solution under constant stress.

Additionally, the cost of disrupting communities is increasing every time an access, repair or maintenance is required - whether this is to service the network asset itself (e.g. a pump) or simply to replace a rocking cover. Choosing a traditional solution however good the design is, may prove a costly choice in the long run due to the ongoing strain of heavily trafficked areas. In response to this problem EJ has combined its decades of experience in supplying access covers to projects worldwide, and have designed the new CT4B range of access solutions.

Ideas for:

- Large and unrestricted access areas
- Installations where the volume of traffic is high
- Reducing the long term maintenance costs
- Minimising traffic disruptions due to access cover failures

Ultimate stability:

The CT4B range of access covers is the result of decades of manufacturing tripod product. Modern design technology enables us ensure the strength where it is needed. A special ribbing system disperses the load with minimal stress to the civil engineering work.

Ultimate durability:

We recognise that excessive use of equipment will cause wear and tear.

Our designers have therefore designed a unique and patented technology of durable component parts. In the same way that heavy goods vehicles will cover hundreds of thousands of kilometres, these units will be serviced accordingly. The same applies for the CT4B series: their seatings are uniquely designed to be replaced when worn (optional). Therefore, there is a minimal disruption and cost compared to a full replacement - which in many cases occurs too late as damage will already have been caused to the surrounding infrastructure.

Our research and collaboration give us the edge in creating the best infrastructure solutions available - solutions that lead the industry, act as best-in-class benchmarks, and satisfy the most demanding customer expectation.

CT4B range a new modular solution

The basic construction uses a ductile iron recessed double triangular cover system with a mild steel galvanised frame. It can be combined to make small units (1/2/3 part covers) duct units or even large removable beam multiple units.

1/2/3 covers unit

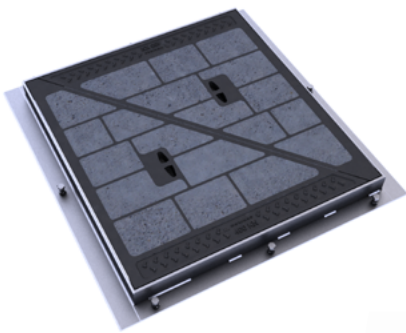

Cover with removable beams

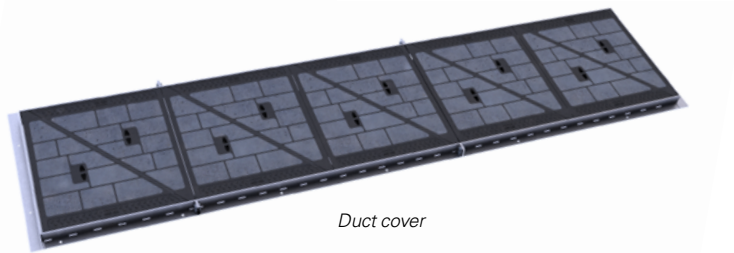
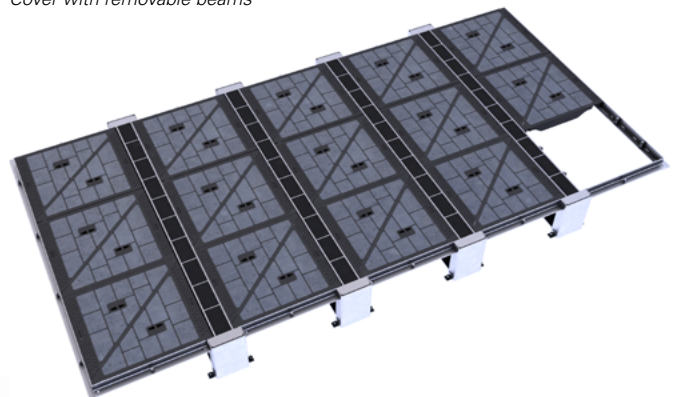

Duct cover

Stability and strength

- Covers are designed to conform to D400 loading applications. Made of spheroidal graphite cast iron according to ISO1083 standard and provided with a water based coating.
- Covers are high quality concrete infill (infill height 85mm). The concrete infill is undertaken in accordance with the requirements of EN124 and with EJ guidelines detailed in this brochure: see our CT technical file at the end of this section.
- Galvanised steel frames and beams.

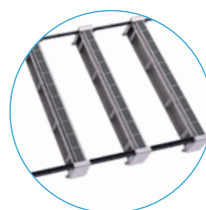
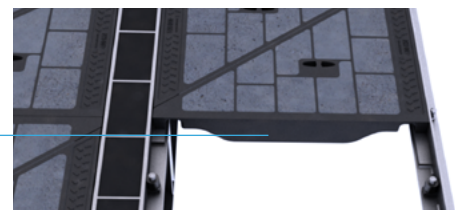
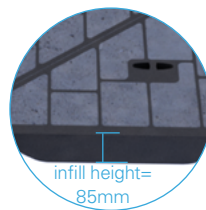

galvanised steel frames and beams

CT4B range

Special features

Silence and durability of installations are achieved thanks to:

- **3-point suspension** (or tripod) seating for ultimate stability
- Minimised lateral movement thanks to the **silent-block technology**, thus minimising friction and subsequent wear of the seating points.
- **The beam is bolted** in its housing and creates a mono-bloc construction, thus making the structure more rigid and more durable.

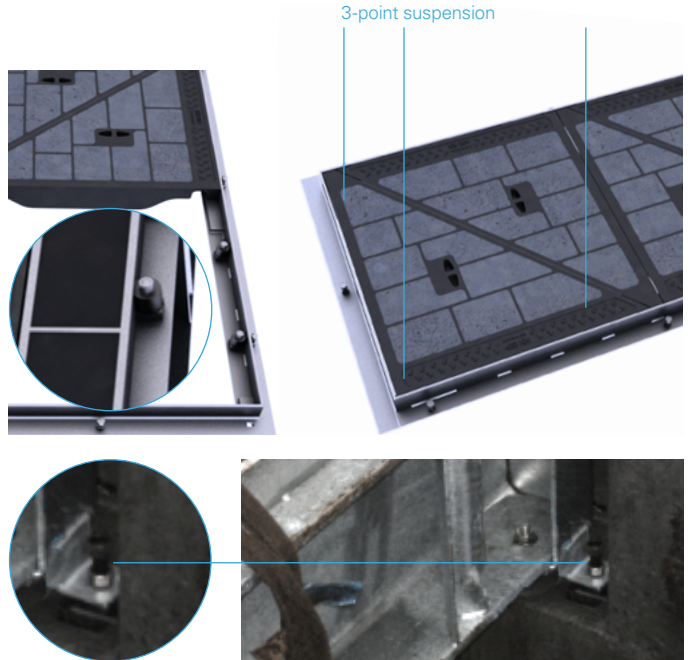

The skid resistance can be further enhanced with the **Premark® Anti-Skid coating** (optional: to be installed on site).

- **The Premark® Anti-Skid coating** can be chosen in a variety of colours and can help identification or mark a danger zone on the road, if the access solution is at a crucial junction of roads.
- **Concrete in-fill covers** to allow similar friction between the surrounding road surface and large multi-span covers.

Handling

The complete opening of the covers is made using **standard slings**. The key holes are easily cleaned, using a simple screwdriver.



concrete infill

On large multi-span access solutions, safety is even more crucial than on any other infrastructure covers.

Large beam multiple units often protect large electro-mechanical devices (filters, pumps, valves, etc.). At EJ, we do not compromise on safety. This is why we propose a vast array of safety and full protection devices to allow the regular and safe maintenance or inspections in the pits. EJ has harnessed all its know-how and field driven technologies to create and propose a vast array of standard yet bespoke safety equipments. Our range of safety grids, safety rails, steps, ladders, etc. are designed according to site specific and unique security strategies.





Paris - France

CT4B - 1/2/3 part covers concrete infill
400 kN

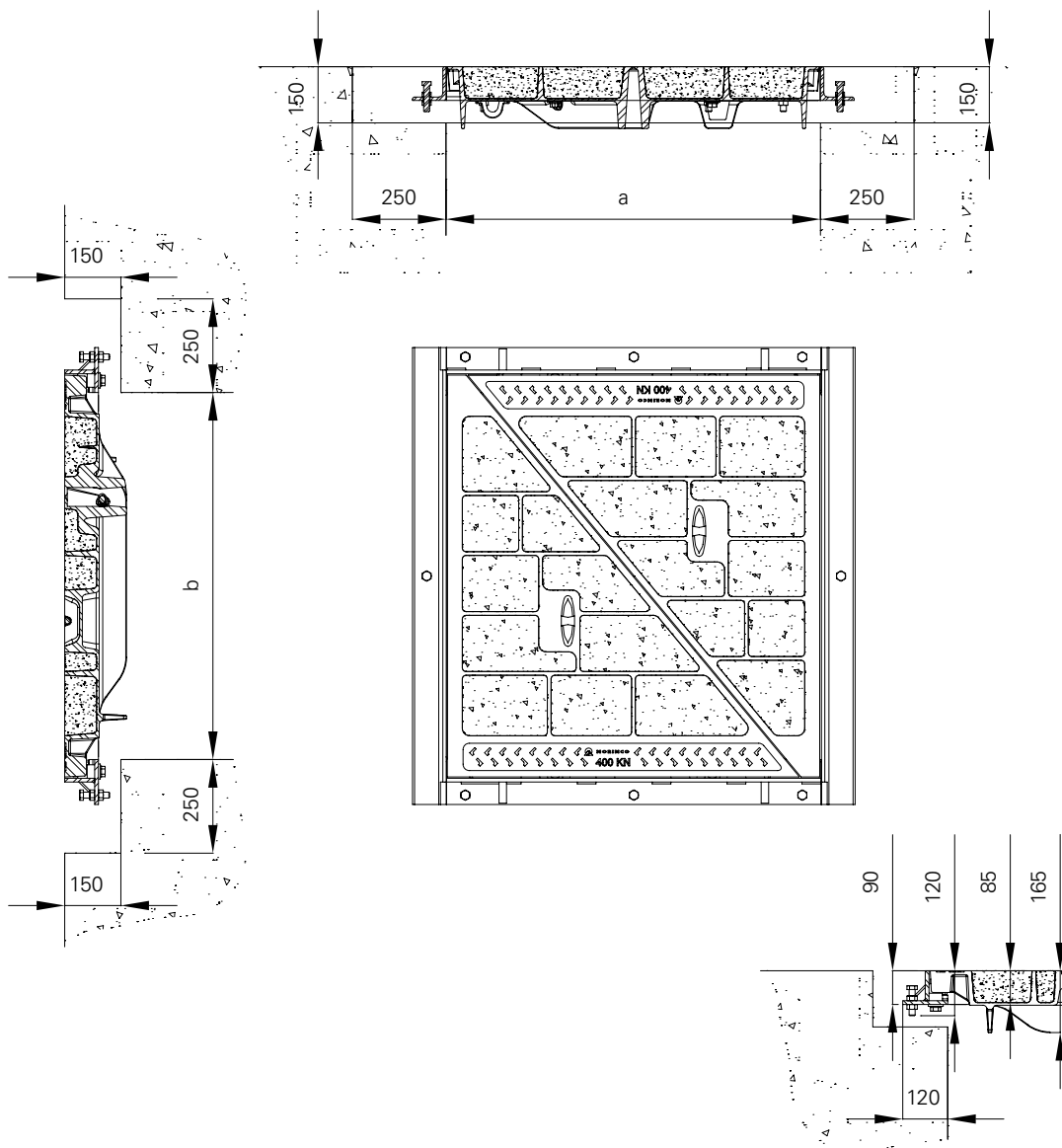
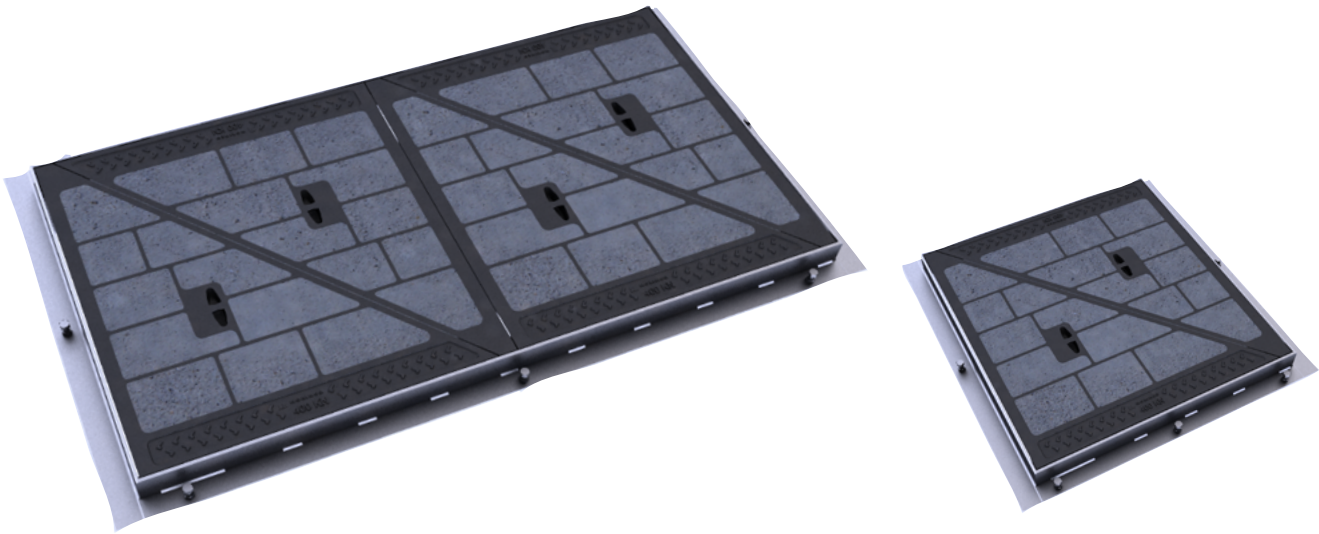

CT4B - 1/2/3 part covers concrete infill 400 kN

Area of installation

400 kN: Design load 40 tonnes. Carriageways of roads (including pedestrian streets), hard shoulders and parking areas, for all types of roads vehicles.

Specification

- CT4B 400kN access cover and frame
- Cover recessed for concrete infill on site
- Clear opening (a x b) in mm: **Reference CT4B** (a x b) in mm
- Rectangular monoblock frame by welding
- Double triangular cover design for stability and non-rocking
- Silent block system prevents rocking of the frame and noise due to traffic of vehicles.
- Non rigid coupling of the cover by bolt
- **Covers:** Ductile cast iron according to ISO 1083 and EN 1563.
- **Frame:** Rolled steel angle to ISO 630.
- Frame incorporates levelling bolts to avoid shimming
- Quality assurance by third party certification to ISO 9001

Option

- Safety railings (see details page 144 - 145)
- Safety grid (see details page 144 - 145)

Handling

- The key holes in the cover allow quick opening by means of a mechanical lifting device (e.g.davit). Removing all covers enables the largest clear opening.

Technical file

- See our installation guideline at the end of this section.

clear opening axb (mm)	overall frame dim. length x width x height (mm)	number of covers	reference
1000 x 980	1180 x 1220 x 90	■	CT4B 100 098
2000 x 980	2186 x 1220 x 90	■ ■	CT4B 200 098
3000 x 980	3186 x 1220 x 90	■ ■ ■	CT4B 300 098

Options

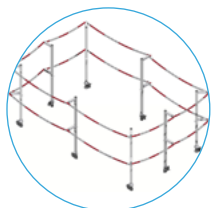

Safety railings



Safety grids

CT4B - Continuous duct covers and frames concrete infill 400 kN

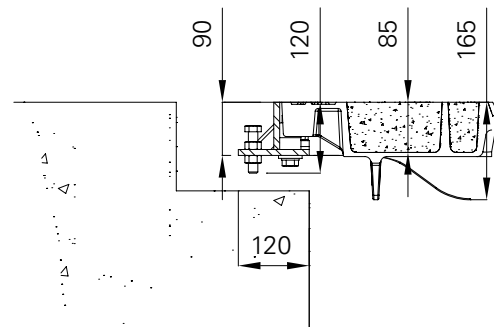
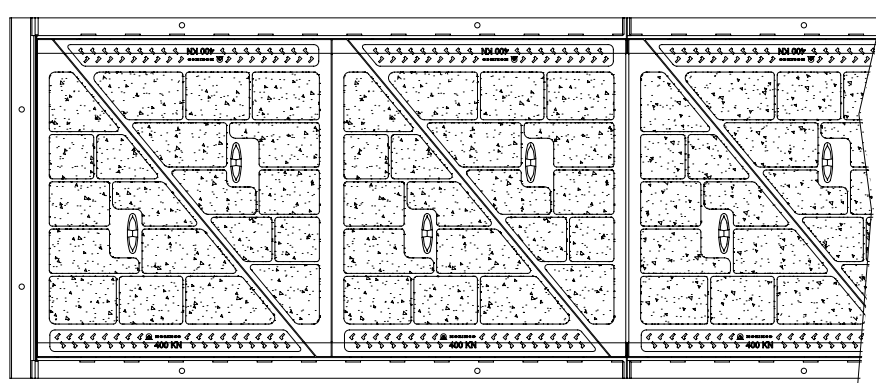
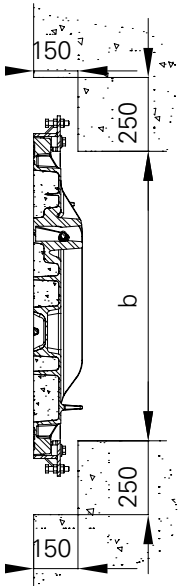
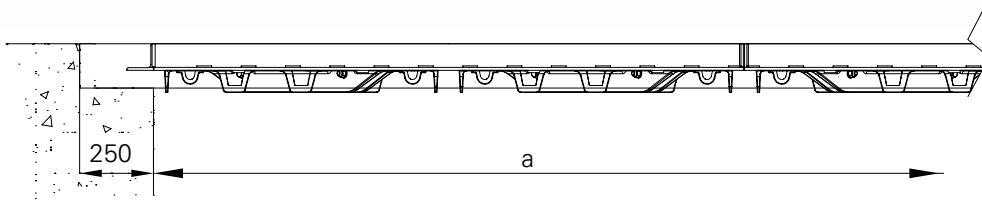
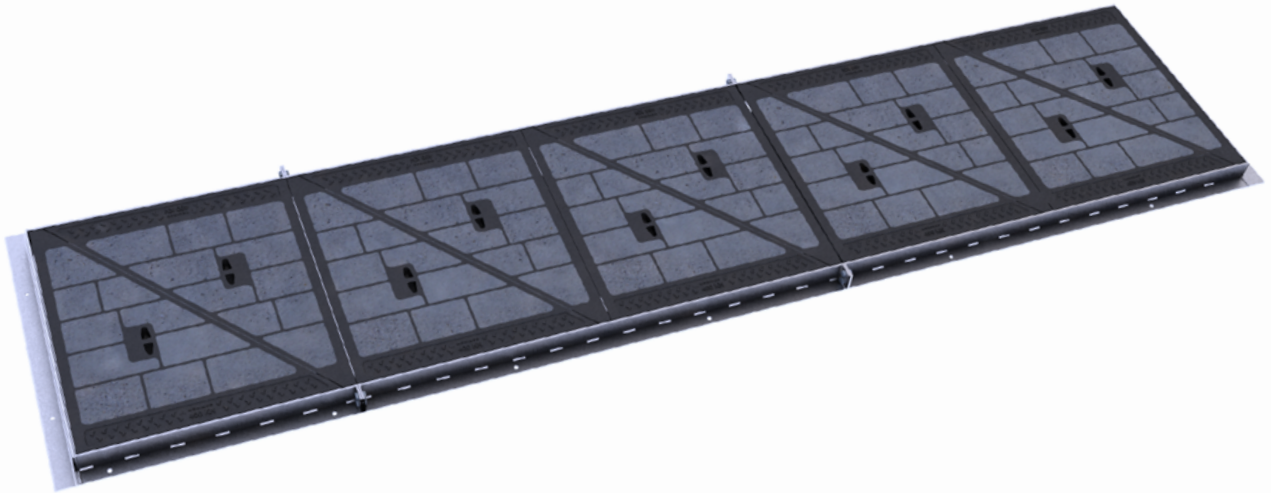

CT4B - Continuous duct covers and frames concrete infill 400 kN

Area of installation

400 kN: Design load 40 tonnes. Carriageways of roads (including pedestrian streets), hard shoulders and parking areas, for all types of roads vehicles.

Specification

- CT4B 400kN access cover and frame
- Cover recessed for concrete infill on site
- Clear opening (a x b) in mm: **Reference CT4B** (a x b) in mm
- Rectangular monoblock frame by welding
- Double triangular cover design for stability and non-rocking
- Silent block system prevents rocking of the frame and noise due to traffic of vehicles
- Non rigid coupling of the cover by bolt
- **Covers:** Ductile cast iron according to ISO 1083 and EN 1563.
- **Frame:** Rolled steel angle to ISO 630.
- Frame incorporates levelling bolts to avoid shimming
- Quality assurance by third party certification to ISO 9001

Option

- Safety railings (see details page 144 - 145)
- Safety grid (see details page 144 - 145)

Handling

- The key holes in the cover allow quick opening by means of a mechanical lifting device (e.g.davit). Removing all covers enables the largest clear opening.

Technical file

- See our installation guideline at the end of this section.

Options

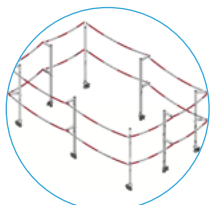

Safety railings



Safety grids

clear opening axb (mm)	overall frame length x width x height (mm)	number of covers	reference
4000 x 980	4180 x 1220 x 90	4	CT4B 400 098
5000 x 980	5180 x 1220 x 90	5	CT4B 500 098
6000 x 980	6180 x 1220 x 90	6	CT4B 600 098
7000 x 980	7180 x 1220 x 90	7	CT4B 700 098
8000 x 980	8180 x 1220 x 90	8	CT4B 800 098
9000 x 980	9180 x 1220 x 90	9	CT4B 900 098
10000 x 980	10180 x 1220 x 90	10	CT4B 1000 098

For longer dimensions you can apply the following formula:

Clear opening **a** = n x 1000 - **b** = 980

Overall dimensions:

length = (n x 1000) + 180

width = 1220

height = 90

n= number of covers

CT4B - Multiple covers with removable beams concrete infill

400 kN

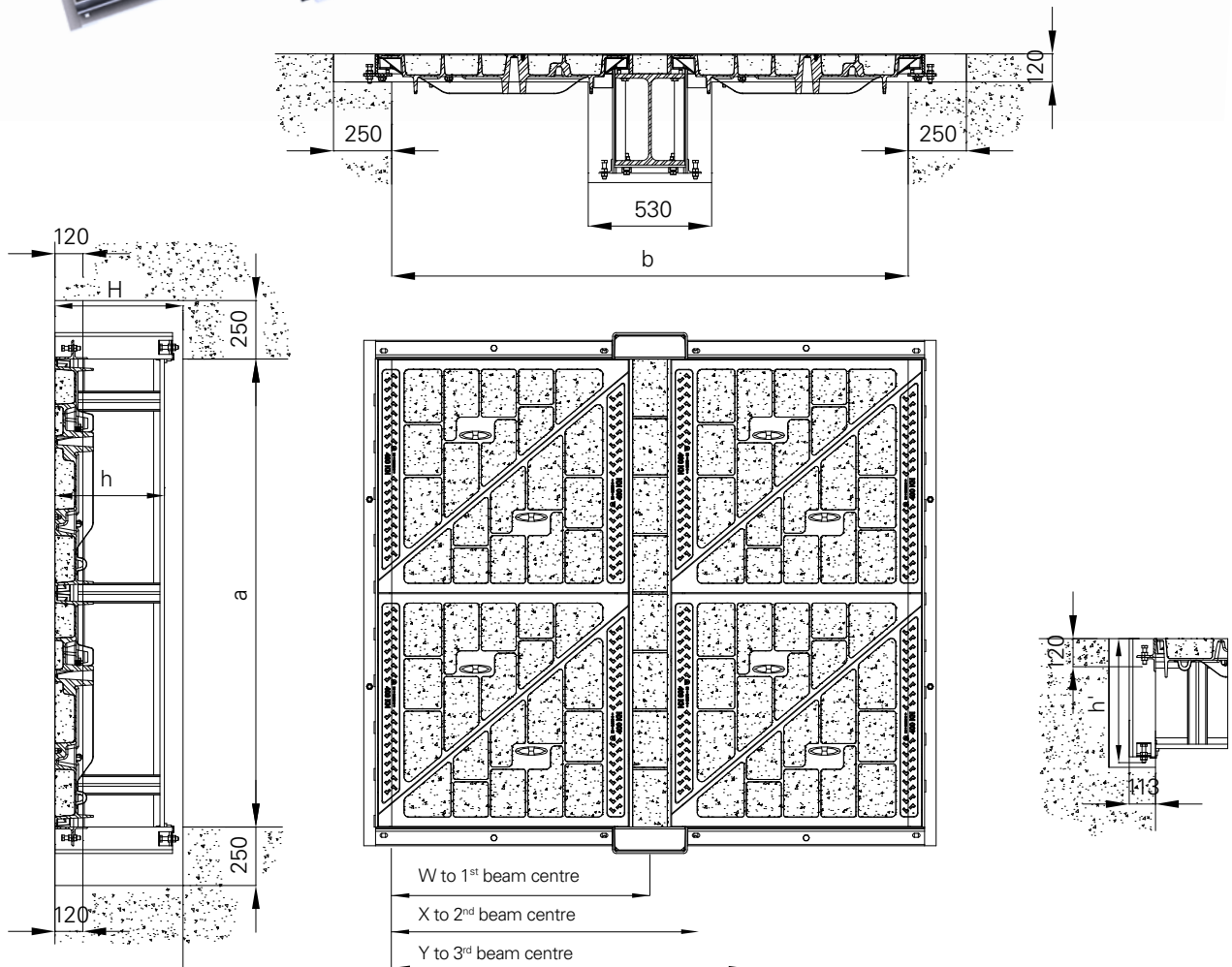
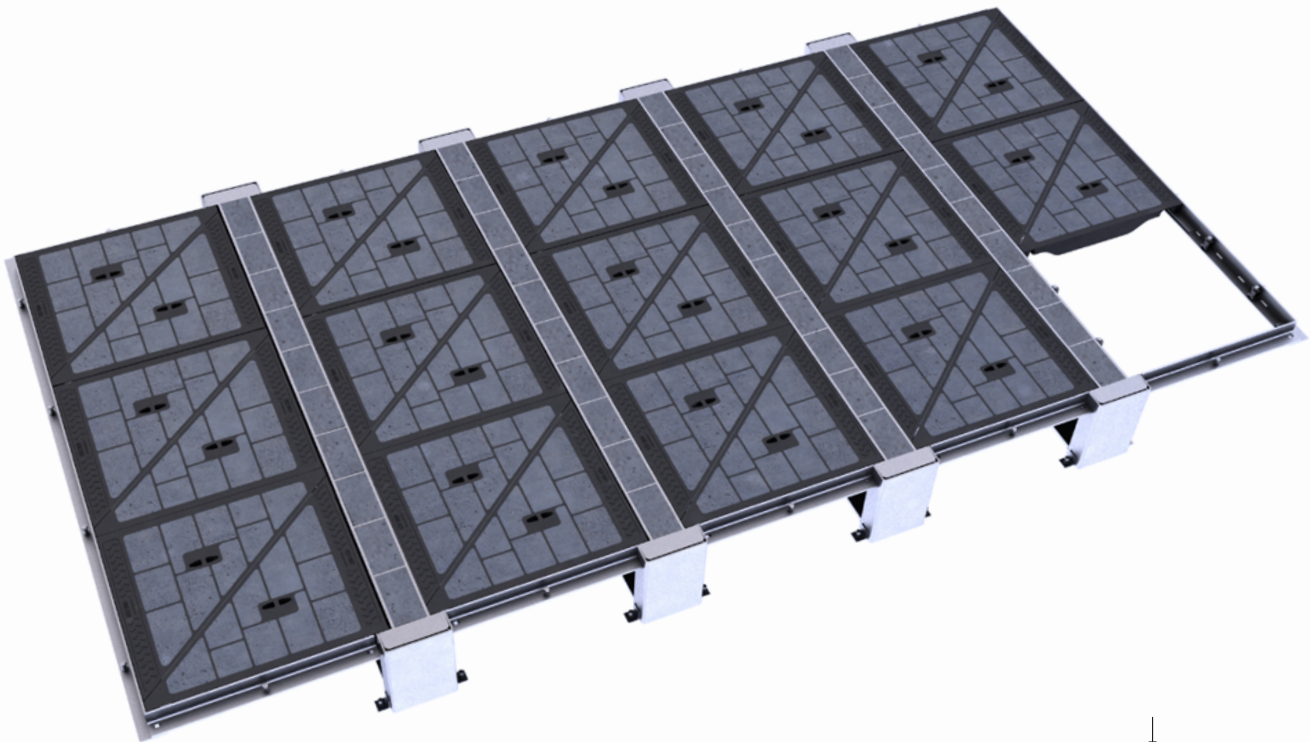

CT4B - Multiple covers with removable beams concrete infill 400 kN

clear opening (a) mm	(b) mm	2200	3480	4740	6000	7260	8520	9780	11040	12300	beam used
	covers	2	3	4	5	6	7	8	9	10	
2000	2	1 beam	2 beams	3 beams	4 beams	5 beams	6 beams	7 beams	8 beams	9 beams	HEA400 (h=520)
3000	3	1 beam	2 beams	3 beams	4 beams	5 beams	6 beams	7 beams	8 beams	9 beams	HEA400 (h=520)
4000	4	1 beam	2 beams	3 beams	4 beams	5 beams	6 beams	7 beams	8 beams	9 beams	HEA500 (h=620)
5000	5	1 beam	2 beams	3 beams	4 beams	5 beams	6 beams	7 beams	8 beams	9 beams	HEA600 (h=720)
beam center W, X, Y		1109	2368	3627	4886	6145	7404	8663	9922	11181	

Area of installation

400 kN: Design load 40 tonnes. Carriageways of roads (including pedestrian streets), hard shoulders and parking areas, for all types of roads vehicles.

Specification

- CT4B 400kN access cover and frame
- Cover recessed for concrete infill on site
- Clear opening (a x b) in mm: **Reference CT4B** (a x b) in mm
- Rectangular monoblock frame by welding
- Double triangular cover design for stability and non-rocking
- Silent block system prevents rocking of the frame and noise due to traffic of vehicles
- Non rigid coupling of the cover by bolt
- **Covers:** Ductile cast iron according to ISO 1083 and EN 1563.
- **Frame:** Rolled steel angle to ISO 630.
- Frame incorporates levelling bolts to avoid shimming
- Quality assurance by third party certification to ISO 9001

Option

- Safety railings (see details page 144 - 145)
- Safety grid (see details page 144 - 145)

Handling

- The key holes in the cover allow quick opening by means of a mechanical lifting device (e.g.davit). Removing all covers enables the largest clear opening.

Technical file

- See our installation guideline at the end of this section.

Options

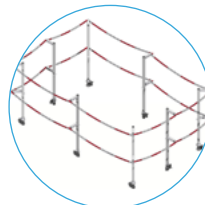

Safety railings



Safety grids

CT4B range

Installation recommendations: 1/2/3 parts covers and frames

Handling

- The product is delivered to site assembled as one unit (items up to 3 covers)
- In order to handle the cover, use a double chain equipped with lifting hook

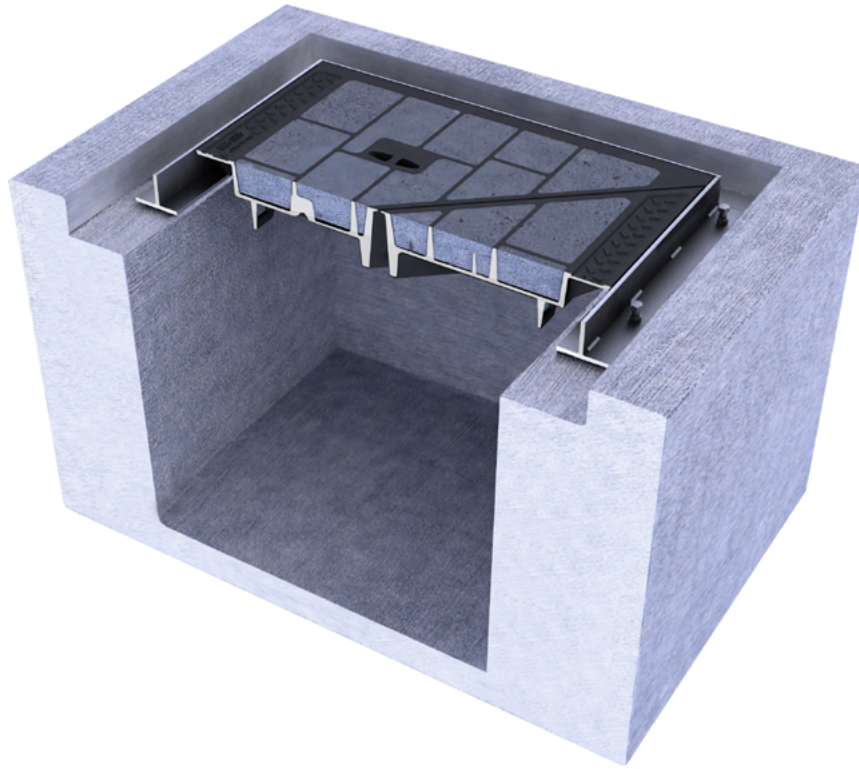

Installation

- Check the rebate according to the drawing provided.
- Correctly center the cover and the frame within the rebate.
- Level to the correct position by using levelling bolts.

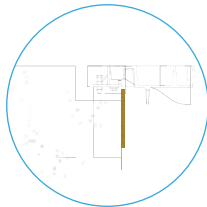

Shuttering

- Shutter the gap between the bottom of the frame and the concrete of the chamber. Position the covers within their respective frames. If applicable, refer to the assembly drawing.

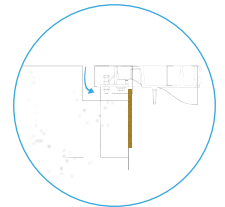

Grouting

- Force the grout beneath the frame.
- Fill in the rebate in successive layers.
- Do not forget to vibrate the grout.
- If there is insufficient time to allow the concrete to fully cure before trafficking, use a rapid non shrinking setting grout.

CT4B range

Installation recommendations: continuous duct covers

Handling

- The item is delivered assembled to site by multiple units according to the continuous duct size.
- In order to handle the cover, use a double chain equipped with a lifting hook .

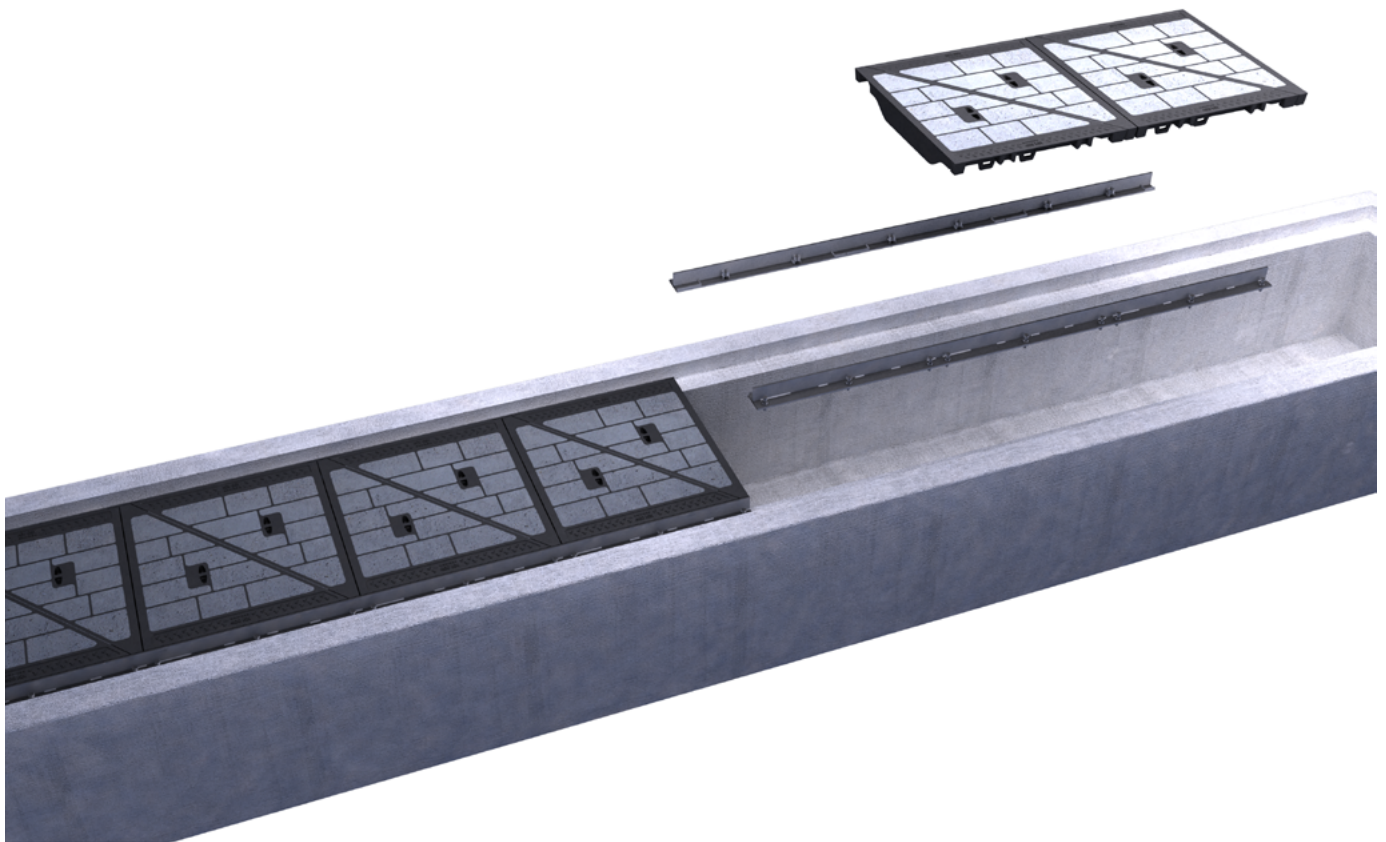

Installation

- Check the rebate according to the drawing provided.
- Correctly center the frame within the rebate.
- Level to the correct position by using levelling bolts
- Assemble the parts of the frame by means of the screws provided for this purpose.
- Level to the correct position by using levelling bolts.
- Install the covers.

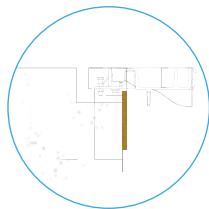

Shuttering

- Shutter the gap between the bottom of the frame and the concrete of the chamber. Position the covers within their respective frames.
- If applicable, refer to the assembly drawing.
- Force the grout beneath the frame.
- Fill in the rebate in successive layers.
- Do not forget to vibrate the grout.

Attention: If there is insufficient time to allow the concrete to fully cure before trafficking, use a rapid setting grout.

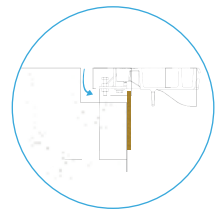

CT4B range

Installation recommendations: multiple covers with removable beams

Handling

- The item is delivered assembled to site by multiple units according to the pit size.
- In order to handle the cover, use a double chain equipped with a lifting hook.

Installation

- Refer to marking drawing.
- Check the assembly reference on box and beam.
- Check the rebate.
- Place the first element (beam + box) in the rebate **1**.
- Adjust the level of the beam with the levelling bolts **2**.



levelling bolts (2)

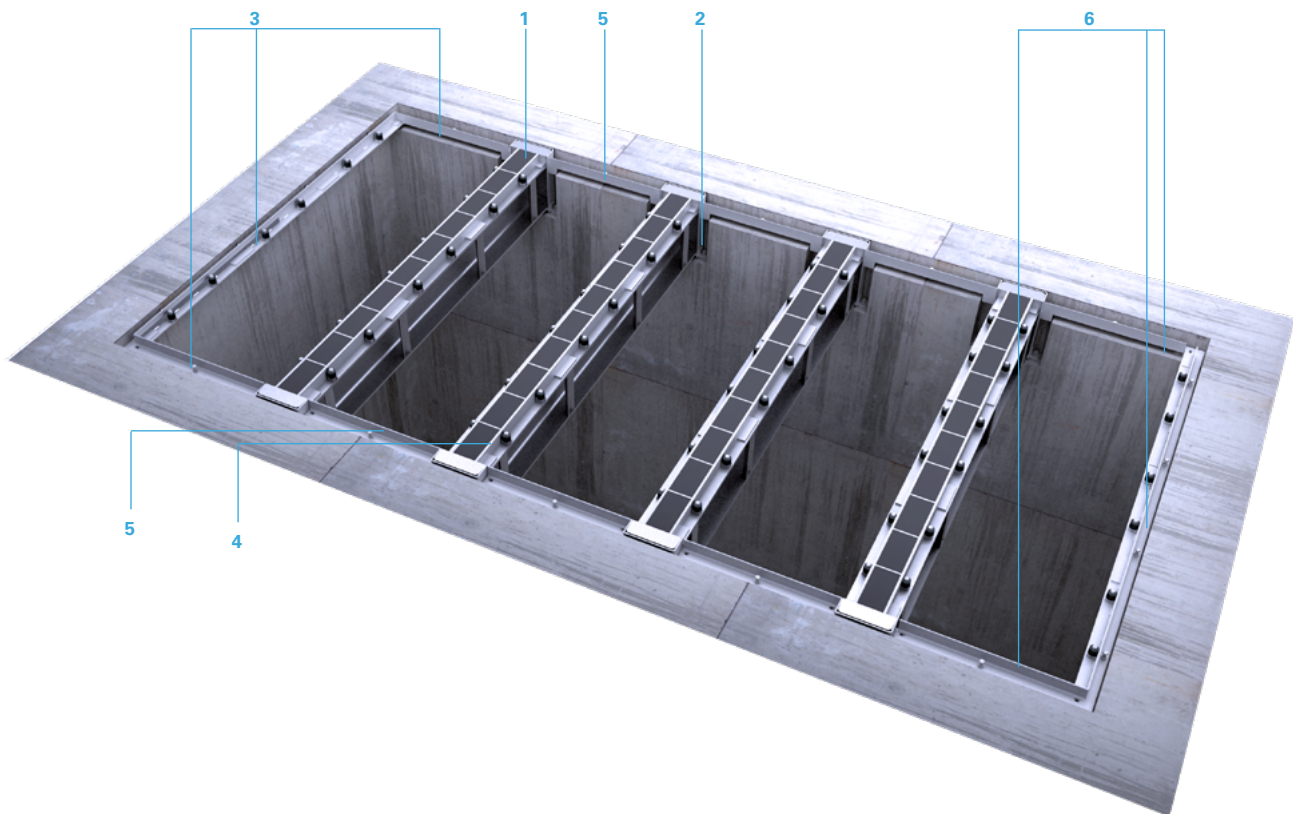

- Install the first extremity in a " U " shape in the rebate and assemble it with the beam previously installed **3**.
- Install the next beam and adjust it (use the supplied braces) **4**.
- Install the extremity plate (between beams) no need to tighten **5**.
- Repeat the two previous steps for all beams.
- Finally install the last extremity in " U " shape **6** in the rebate and assemble it with the beam previously installed.
- Place the covers in the frame
- Finalise the adjustment (alignment, level by using the levelling bolts)

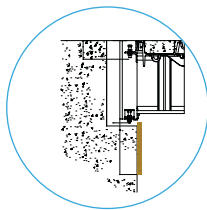

Shuttering

- To proceed with the installation, do not remove all the covers, but only 1 or 2 units, in order to access beneath the product.

Caution: the boxes must not be infilled with concrete.

Carefully fill concrete below frame until it is full.

- Fill the rebate.

Caution: If you only have limited time for concrete curing, we recommend the use of fast setting concrete solutions.

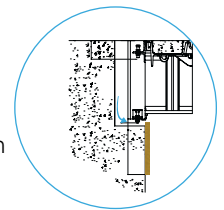

CT4S range

- 112 Introducing the CT4S range
 - CT4S...075** series
- 116 Solid top 1/2/3 parts covers
- 116 Solid top continuous duct covers
- 118 Solid top covers with removable beams
- 120 Installation recommendations
- CT4S...100** series
- 122 Solid top 1/2/3 parts covers
- 122 Solid top continuous duct covers
- 124 Solid top covers with removable beams
- 126 Installation recommendations

CT4S range

Modular covers and frames

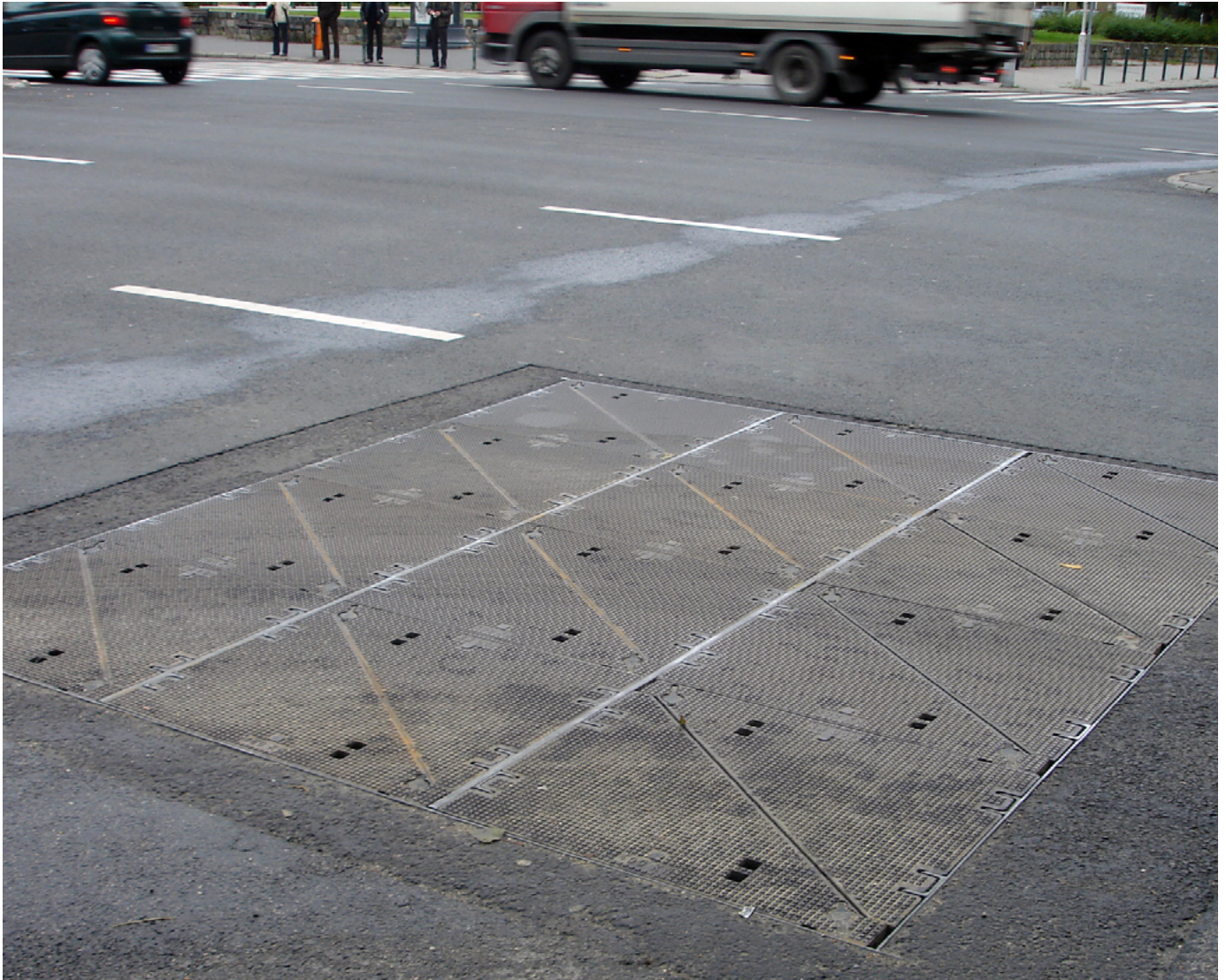

Budapest - Hungary

CT4S is a comprehensive range of access covers and frames designed for various underground services: sewerage, electrical pits, etc. in various environments. Designed to meet customer requirements, **CT4S** is available in a wide range of dimensions in order to cover single or long ducts access gratings as well as large chambers. The **CT4S** cover incorporates the 3 point suspension for non rock performance. This ensures stability and facilitates installation.

CT4S range

Modular covers and frames

Modular construction

The use of modular elements gives a vast range of sizes : **1/2/3 part covers**.

Frame elements (side frames and end plates) are assembled using bolts to provide linear openings for even the longest ducts: **continuous duct covers**.

Above clear opening spans of 1000 mm, CT4S units employ removable beams supported in boxes which are fixed to the frames. This allows the construction of units to suit the largest openings: **multiple unit with removable beams**.

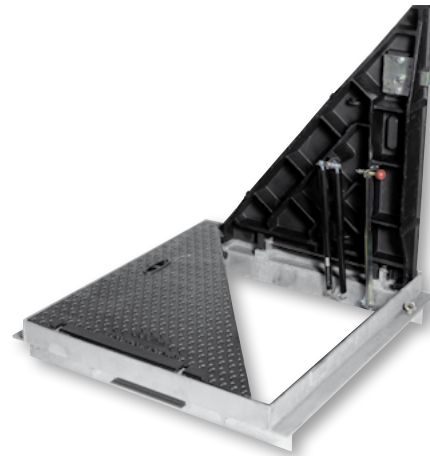

1/2/3 covers

continuous duct covers



multiple beams cover



Stability, strength and durability

- Covers are designed to conform to D400 loading applications. Made of spheroidal graphite cast iron according to ISO1083 standard and provided with a water based coating
- Covers are solid top with anti skid surface.
- Galvanised steel frames and beams

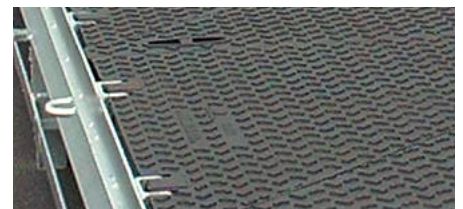
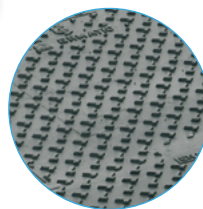

Security

- The **CT4S...075** series are provided with an OTC locking system. Optional: 1/4 turn locking system.
- The **CT4S...100** series are provided with an MTV locking system.

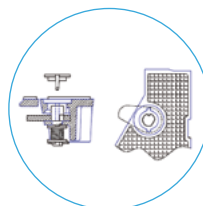

CT4S range

Modular covers and frames

Minimal noise and long term durability is achieved by:

- **The 3 point suspension** for non rock performance.
When correctly installed, according to the installation recommendations, the CT4S range of covers are stable under traffic conditions.

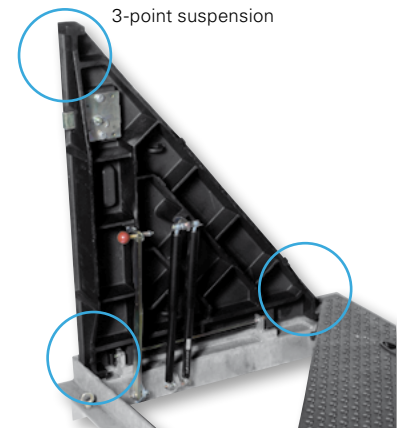

Types of surface finish available

Solid top cover with uniform anti-slip surface

This cover offers unparalleled performance .

If an increased anti-skid resistance is required covers can be provided with **Premark® Anti-skid coating**

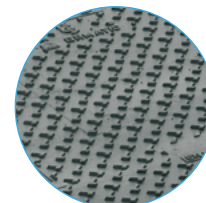

uniform anti-slip surface



Premark® Anti-Skid surface

Easy handling

- Option: **CT4S...075** can be provided with a strut assisted opening.
- The **CT4S...100** series are provided with a strut assisted opening . Option: the strut can be stainless steel.

Optional safety accessories: grids and railings

All covers can be provided with safety grids and safety railings to allow for safe access to the chamber facilitating effective maintenance of equipment. For more details see page 24.



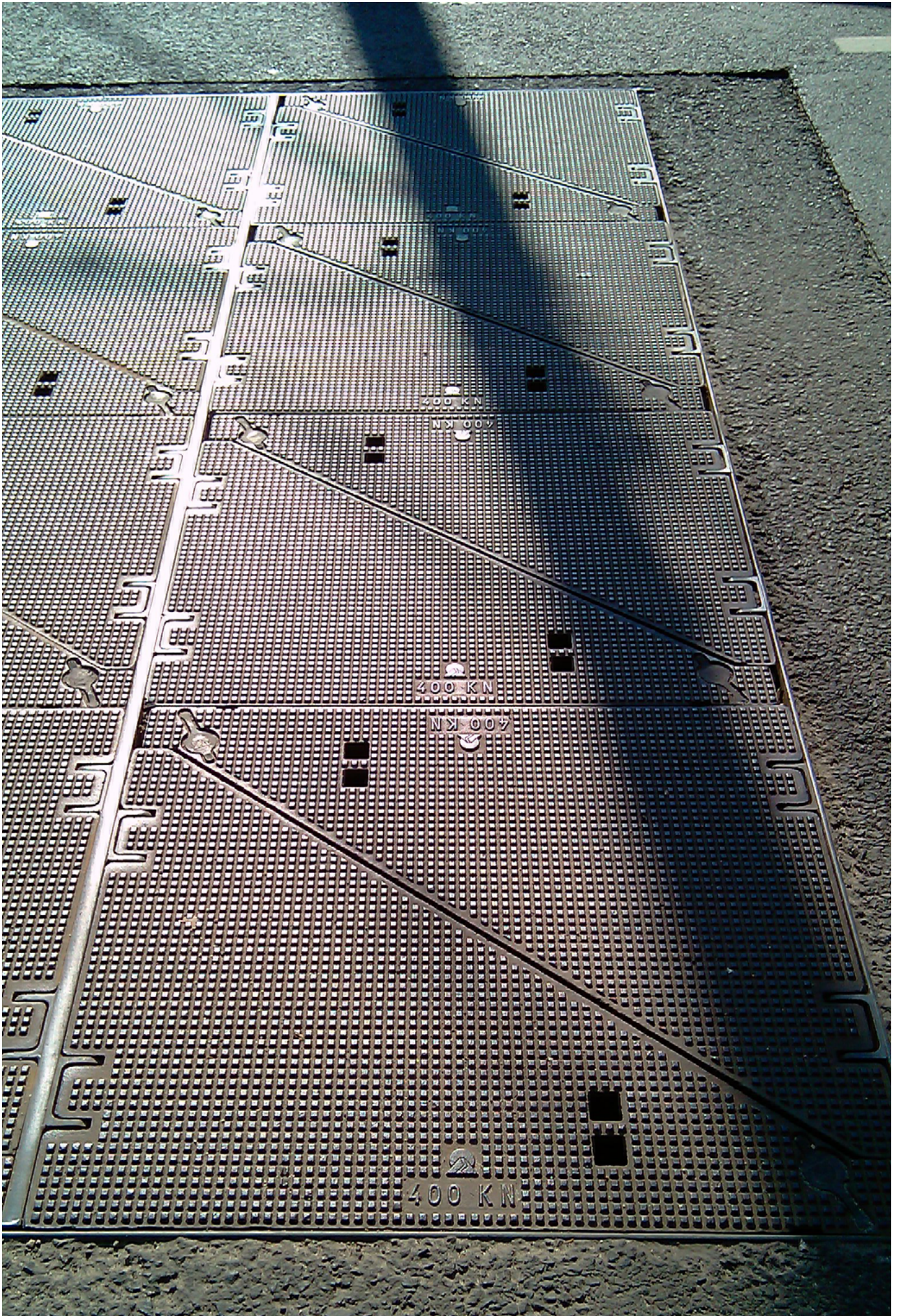

CT4S ...075 - Solid top 1/2/3 covers and continuous duct covers 400 kN

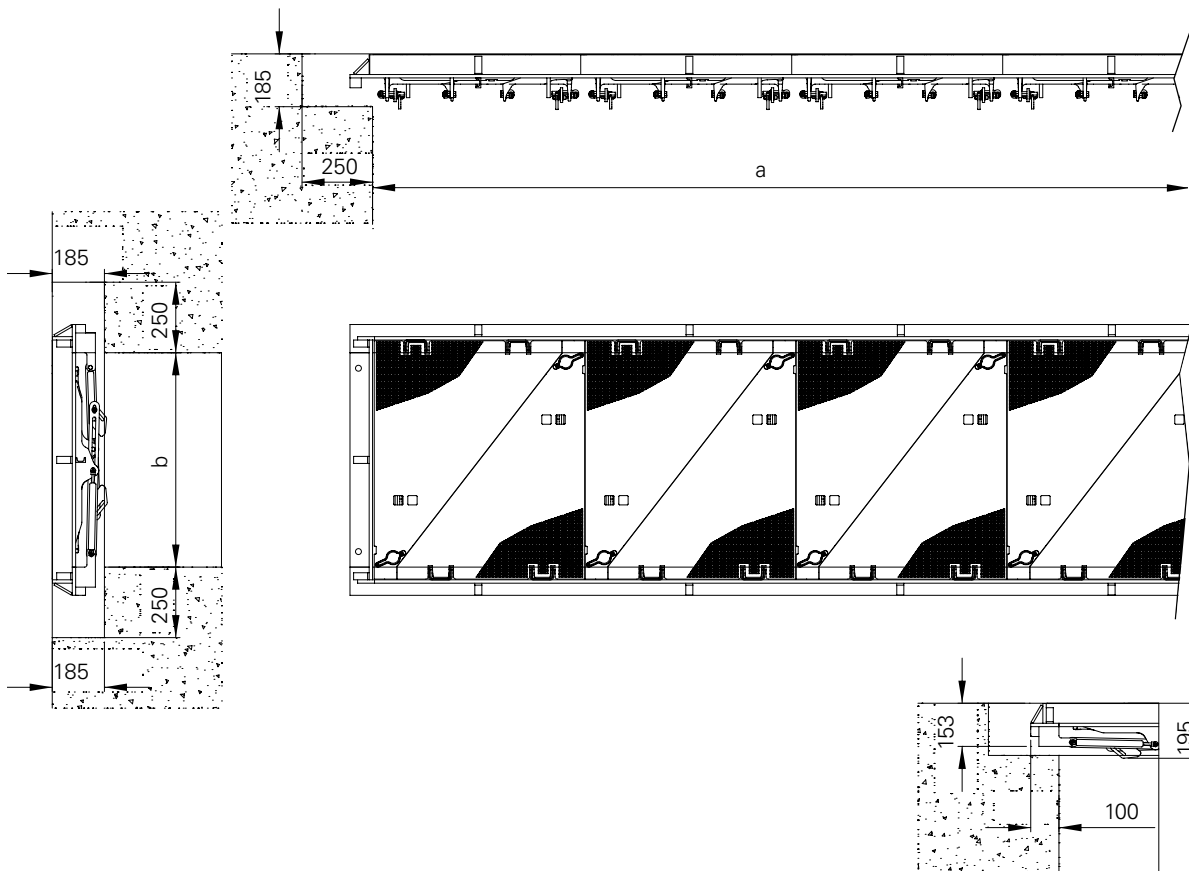
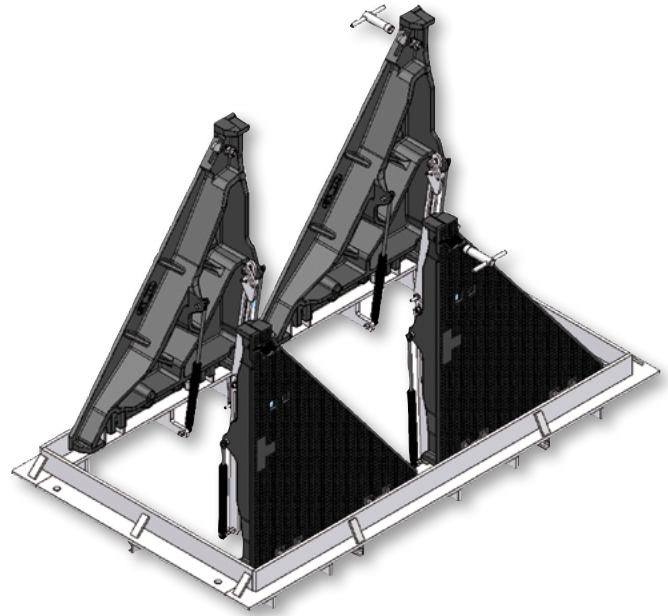

CT4S ...075 - Solid top 1/2/3 covers and continuous duct covers 400 kN

Area of installation

400 kN: Design load 40 tonnes. Carriageways of roads (including pedestrian streets), hard shoulders and parking areas, for all types of roads vehicles.

Specification

- **Frame:** Mild steel to S 235 JR - NF EN 10025 Hot Dip Galvanised according to NF EN ISO 1461.
- **Cover:** Spheroidal graphite cast iron according to ISO 1083 and EN NF 1563
- Hinged access covers and frames blocking at 90° for safety
- 3 point suspension for non rock performance. This ensures stability and facilitates installation.

Option

- VAF 1/4 turn locking system
- Assisted opening by strut
- Safety grids (see detail on pages 144-145)
- Safety railings (see detail on pages 144-145)
- Premark® Anti-Skid coating

Technical file

- Installation recommendations: see page 120 -121

Options

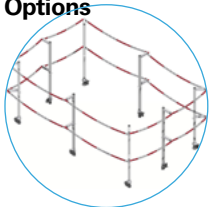

Safety railings



Safety grids

clear opening axb (mm)	overall frame dim. length x width (mm)	number of covers	reference
1/2/3 covers 750 x 760	960 x 950	■	CT4S 075 076 A
1502 x 760	960 x 1702	■■	CT4S 150 076 A
2250 x 760 continuous ducts	960 x 2455	■■■	CT4S 225 076 A

For longer dimensions you can apply the following formula

- Clear opening: **a** = n x 750
b = 760
- Overall dimensions:
length = (n x 750) + 200
width = 960
height = 150
- **n**= number of covers

CT4S ...075 - Solid top multiple covers with removable beams

400 kN

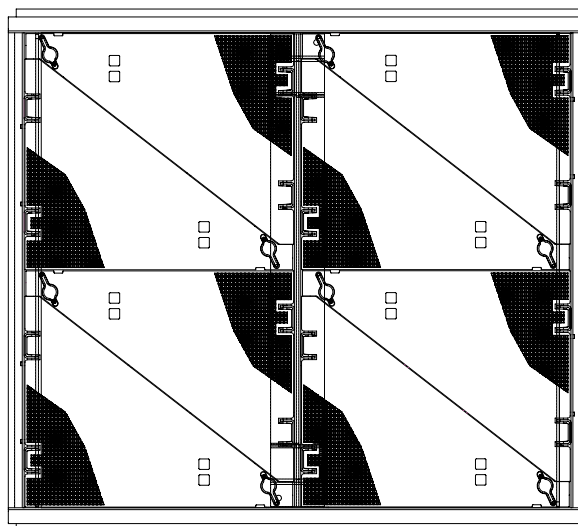
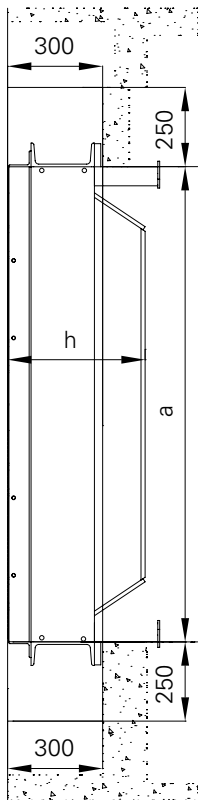
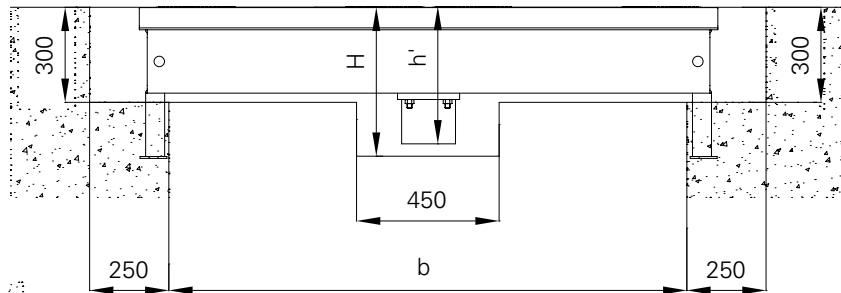

W to 1st beam centre
 X to 2nd beam centre
 Y to 3rd beam centre

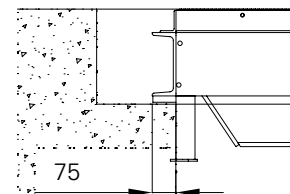

CT4S ...075 - Solid top multiple covers with removable beams

400 kN

clear opening (a) mm	(b) mm	1630	2518	3406	4294	5182	6070	6958	7846	8734	beam used
	covers	2	3	4	5	6	7	8	9	10	
1500	2	1 beam	2 beams	3 beams	4 beams	5 beams	6 beams	7 beams	8 beams	9 beams	IPE360 (h=430)
2250	3	1 beam	2 beams	3 beams	4 beams	5 beams	6 beams	7 beams	8 beams	9 beams	IPE360 (h=430)
3000	4	1 beam	2 beams	3 beams	4 beams	5 beams	6 beams	7 beams	8 beams	9 beams	IPE360 (h=430)
3750	5	1 beam	2 beams	3 beams	4 beams	5 beams	6 beams	7 beams	8 beams	9 beams	IPE400 (h=470)
4500	6	1 beam	2 beams	3 beams	4 beams	5 beams	6 beams	7 beams	8 beams	9 beams	
beam center W, X, Y		818	1691	2564	3437	4310	5183	6056	6929	7802	

Area of installation

400 kN: Design load 40 tonnes. Carriageways of roads (including pedestrian streets), hard shoulders and parking areas, for all types of roads vehicles.

Specification

- **Frame:** Mild steel to S 235 JR - NF EN 10025 Hot Dip Galvanised according to NF EN ISO 1461.
- **Cover:** Spheroidal graphite cast iron according to ISO 1083 and EN NF 1563
- Hinged access covers and frames blocking at 90° for safety
- 3 point suspension of covers to ensure stability and minimise noise and vibration.

Option

- VAF 1/4 turn locking system
- Assisted opening by strut
- Safety grids (see details page 144 - 145)
- Safety railings (see details page 144 - 145)

Technical file

- Installation recommendations: see page 120 - 121

Options

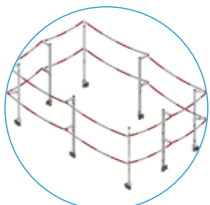

Safety railings



Safety grids

CT4S ...75 series

Installation recommendations: 1/2/3 part covers and continuous duct

1/2/3 part covers

Handling

- The product is delivered assembled to site as one unit (items up to 3 covers).
- In order to handle the cover, use a double chain equipped with lifting hook.

Installation

- Check the rebate according to the drawing provided.
- Correctly center the cover and the frame within the rebate.
- Level to the correct position by using levelling bolts.

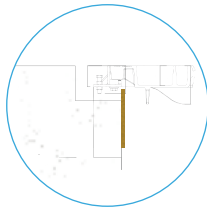

Shuttering

- Shutter the gap between the bottom of the frame and the concrete of the chamber.
- Position the covers within their respective frames.
If necessary, refer to the assembly drawing.

Grouting

- Force the grout beneath the frame.
- Fill in the rebate in successive layers.
- Do not forget to vibrate the grout.
- If there is insufficient time to allow the concrete to fully cure before trafficking, use a rapid setting, non shrinking grout.

Continuous duct covers

Handling

- The product is delivered assembled to site in multiple units according to the continuous duct size.
- In order to handle the cover, use a double chain equipped with a lifting hook.

Installation

Please consult us.

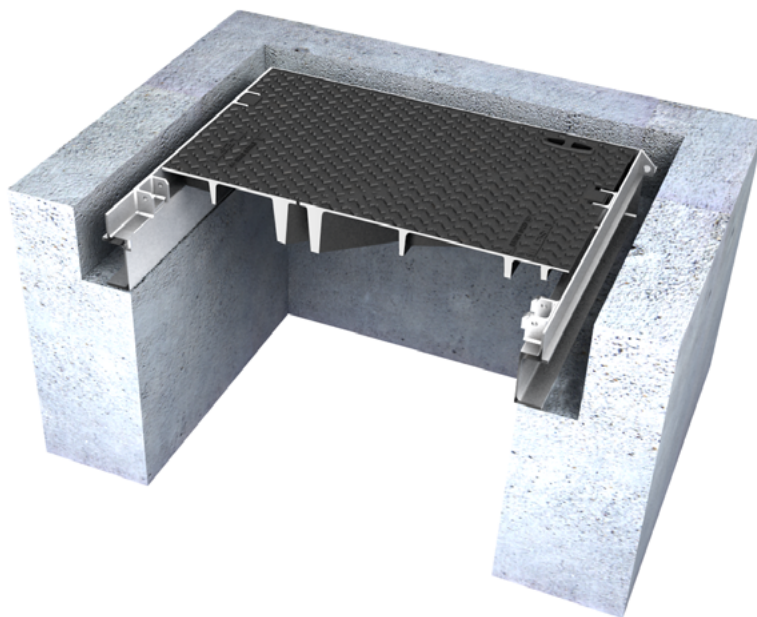

CT4S ...75 series

Installation recommendations: multiple covers with removable

Handling

- The product is delivered assembled to site in multiple units according to the pit size.
- In order to handle the cover, use a double chain equipped with a lifting hook.

Installation

Please consult us.

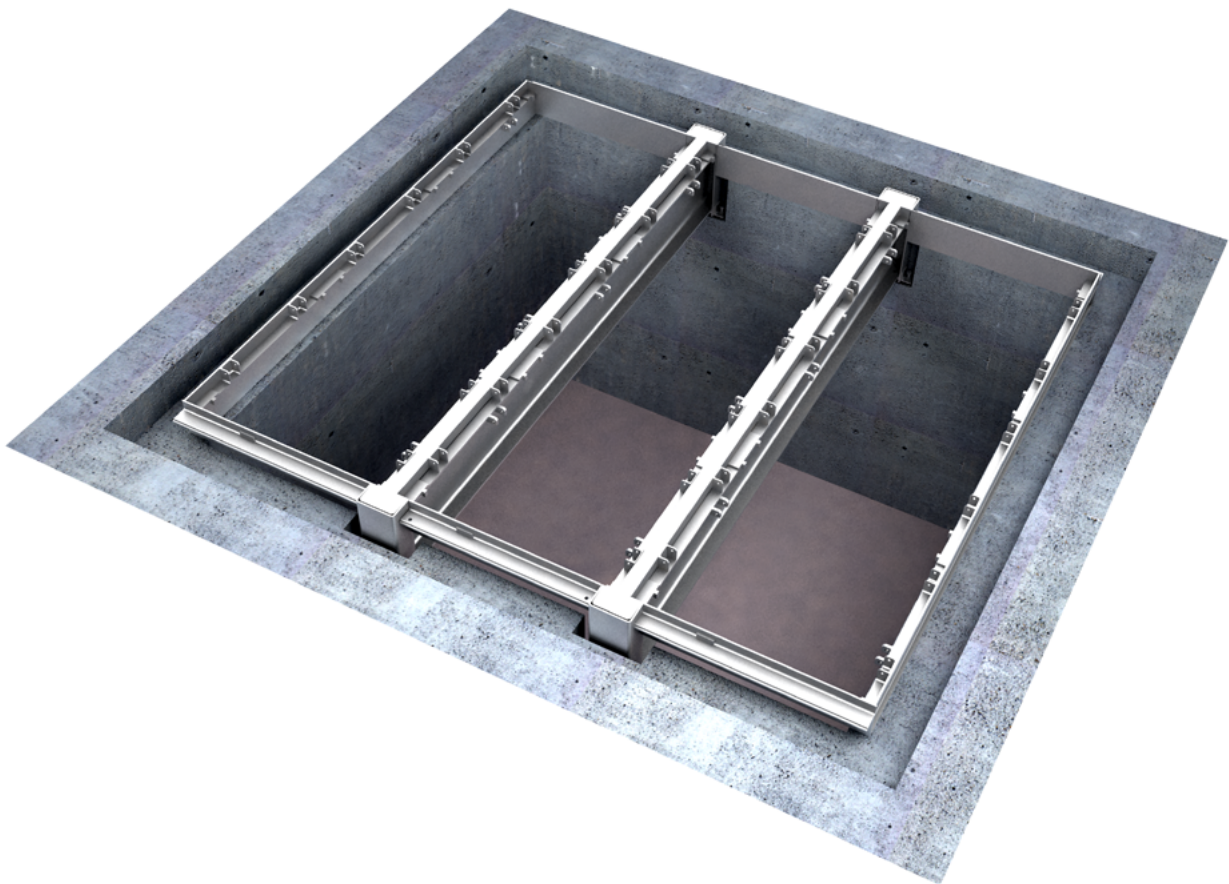

CT4S ...100 - 1/2/3 covers and continuous duct covers and frames 400 kN

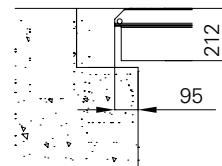
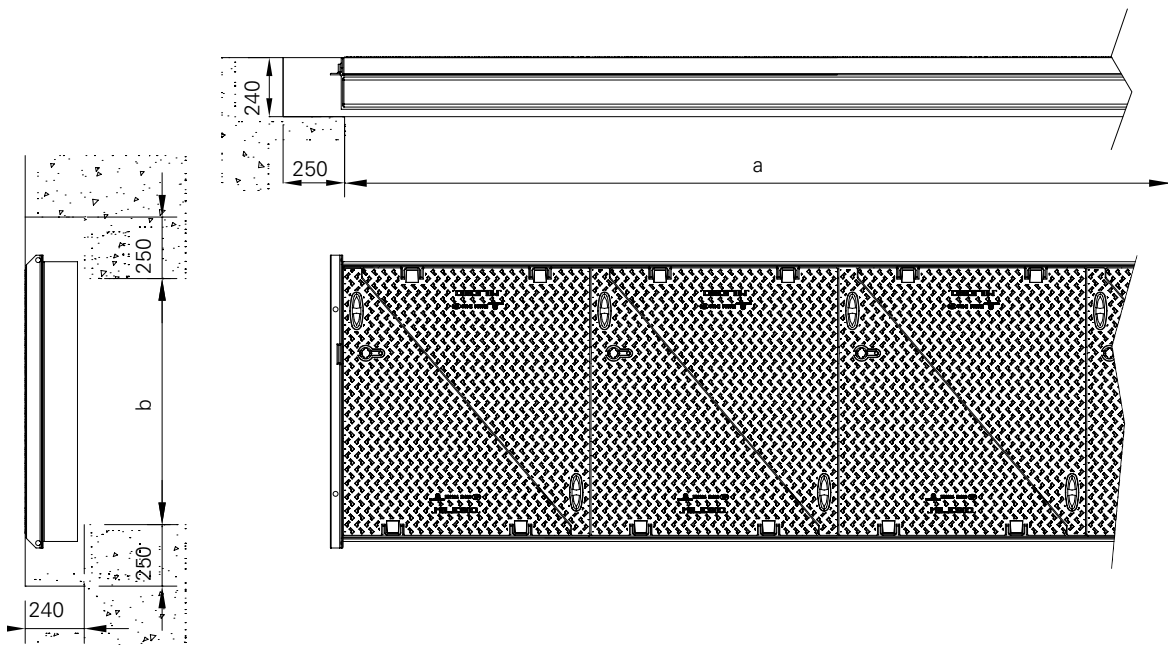

CT4S ...100 - 1/2/3 covers and continuous duct covers and frames 400 kN

Area of installation

400 kN: Design load 40 tonnes. Carriageways of roads (including pedestrian streets), hard shoulders and parking areas, for all types of roads vehicles.

clear opening axb (mm)	overall frame dim. length x width (mm)	number of covers	reference
1000 x 1000	1140 x 1140	■	CT4S 100 100 AHVPC
2000 x 1000	2140 x 1140	■ ■	CT4S 200 100 AHVPC
3000 x 1000	3140 x 1140	■ ■ ■	CT4S 300 100 AHVPC

Specification

- **Frame:** Mild steel to S 235 JR - NF EN 10025
Hot Dip Galvanised according to NF EN ISO 1461.
- **Cover:** Spheroidal graphite cast iron according to ISO 1083 and EN NF 1563
- Hinged access covers and frames blocking at 90° for safety
- 3 point suspension of covers to ensure stability and minimise noise and vibration.
- Covers provided with MTV locking system, blocking when opened for handling
- Assisted opening by strut
- Key hole protected by PE plug
- Plug clipped into the cover to avoid displacement

For longer dimensions you can apply the following formula

- Clear opening: **a** = $n \times 1000$
b = 1000
- Overall dimensions:
length = $(n \times 1000) + 140$
width = 1140
height = 215 mm
- **n** = number of covers

Option

- Safety grids (see details page 144 - 145)
- Safety railings (see details page 144 - 145)
- Stainless steel strut

Technical file

- Installation recommendations: see page 126 - 127

Options

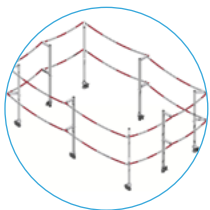

Safety railings



Safety grids

CT4S ...100 - Solid top multiple covers with removable beams

400 kN

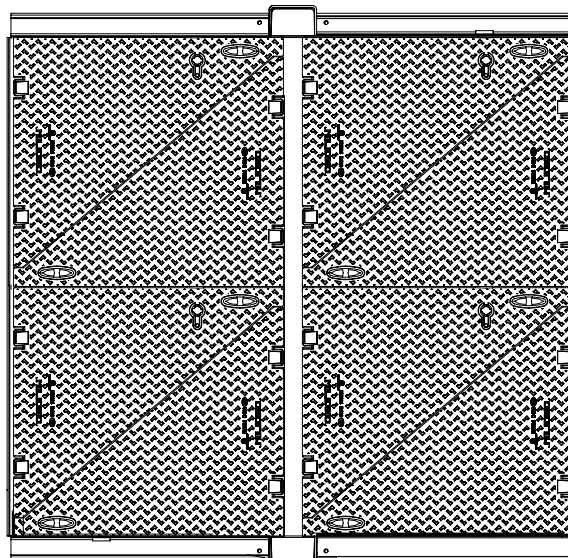
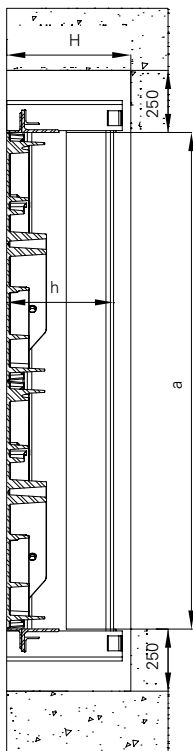
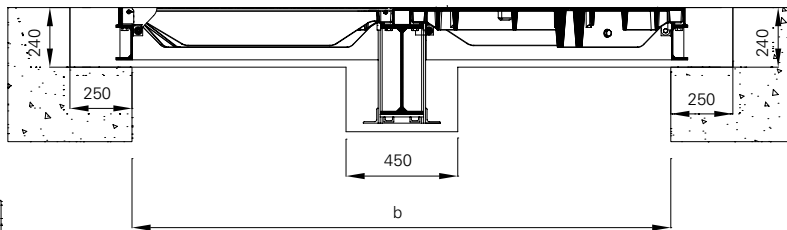

W to 1st beam centre
 X to 2nd beam centre
 Y to 3rd beam centre

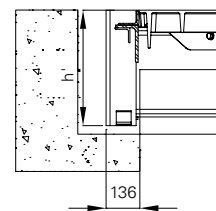

CT4S ...100 - Solid top multiple covers with removable beams

400 kN

clear opening (a) mm	(b) mm	2130	3300	4470	5640	6810	7980	9150	10320	11490	beam used
	covers	2	3	4	5	6	7	8	9	10	
2000	2	1 beam	2 beams	3 beams	4 beams	5 beams	6 beams	7 beams	8 beams	9 beams	HEA400 (h=520)
3000	3	1 beam	2 beams	3 beams	4 beams	5 beams	6 beams	7 beams	8 beams	9 beams	HEA400 (h=520)
4000	4	1 beam	2 beams	3 beams	4 beams	5 beams	6 beams	7 beams	8 beams	9 beams	HEA500 (h=620)
5000	5	1 beam	2 beams	3 beams	4 beams	5 beams	6 beams	7 beams	8 beams	9 beams	HEA600 (h=720)
beam center W, X, Y		1085	2255	3425	4595	5765	6935	8105	9275	10445	

Area of installation

400 kN: Design load 40 tonnes. Carriageways of roads (including pedestrian streets), hard shoulders and parking areas, for all types of roads vehicles.

Specification

- **Frame:** Mild steel to S 235 JR - NF EN 10025
Hot Dip Galvanised according to NF EN ISO 1461.
- **Cover:** Spheroidal graphite cast iron according to ISO 1083 and EN NF 1563
- Hinged access covers and frames blocking at 90° for safety
- 3 point suspension of covers to ensure stability and minimise noise and vibration.
- Covers provided with MTV locking system, blocking when opened for handling
- Assisted opening by strut
- Key hole protected by PE plug
- Plug clipped into the cover to avoid it to be lost

Option

- Safety grids (see details page 144 - 145)
- Safety railings (see details page 144 - 145)
- Stainless steel strut

Technical file

- Installation recommendations: see pages 126 -127

Options

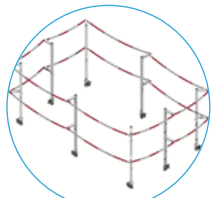

Safety railings



Safety grids

CT4S ...100 series

Installation recommendations: 1/2/3 part covers and continuous duct

1/2/3 part covers

Handling

- The product is delivered assembled to site as one unit.
- In order to handle the cover, use a double chain equipped with lifting hook.

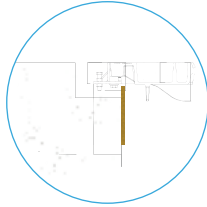

Installation

- Check the rebate according to the provided drawing.
- Correctly centre the cover and the frame within the rebate
- Level to the correct position by using levelling bolts.

Shuttering

- Shutter the gap between the bottom of the frame and the concrete of the chamber.
- Position the covers within their respective frames. If applicable, refer to the assembly drawing.

Grouting

- Force the grout beneath the frame.
- Fill in the rebate in successive layers.
- Do not forget to vibrate the grout.
- If there is insufficient time to allow the concrete to fully cure before trafficking, use a rapid setting, non shrinking grout.

Continuous duct covers

Handling

- The item is delivered assembled to site by multiple units according to the continuous duct size.
- In order to handle the cover, use a double chain equipped with a lifting hook.

Installation

Please consult us.

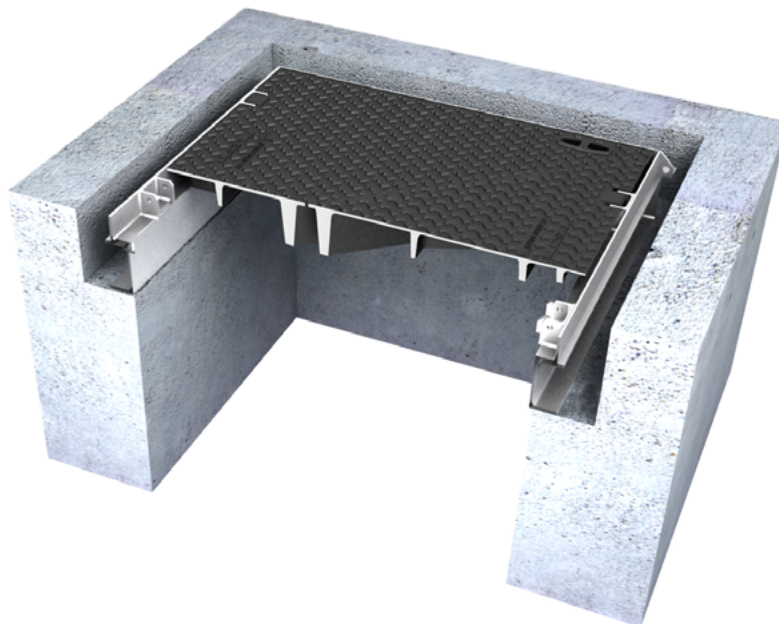

CT4S...100 series

Installation recommendations: multiple covers with removable beam

Handling

- The product is delivered assembled to site by multiple units according to the pit size.
- In order to handle the cover, use a double chain equipped with lifting hook.

Installation

Please consult us.

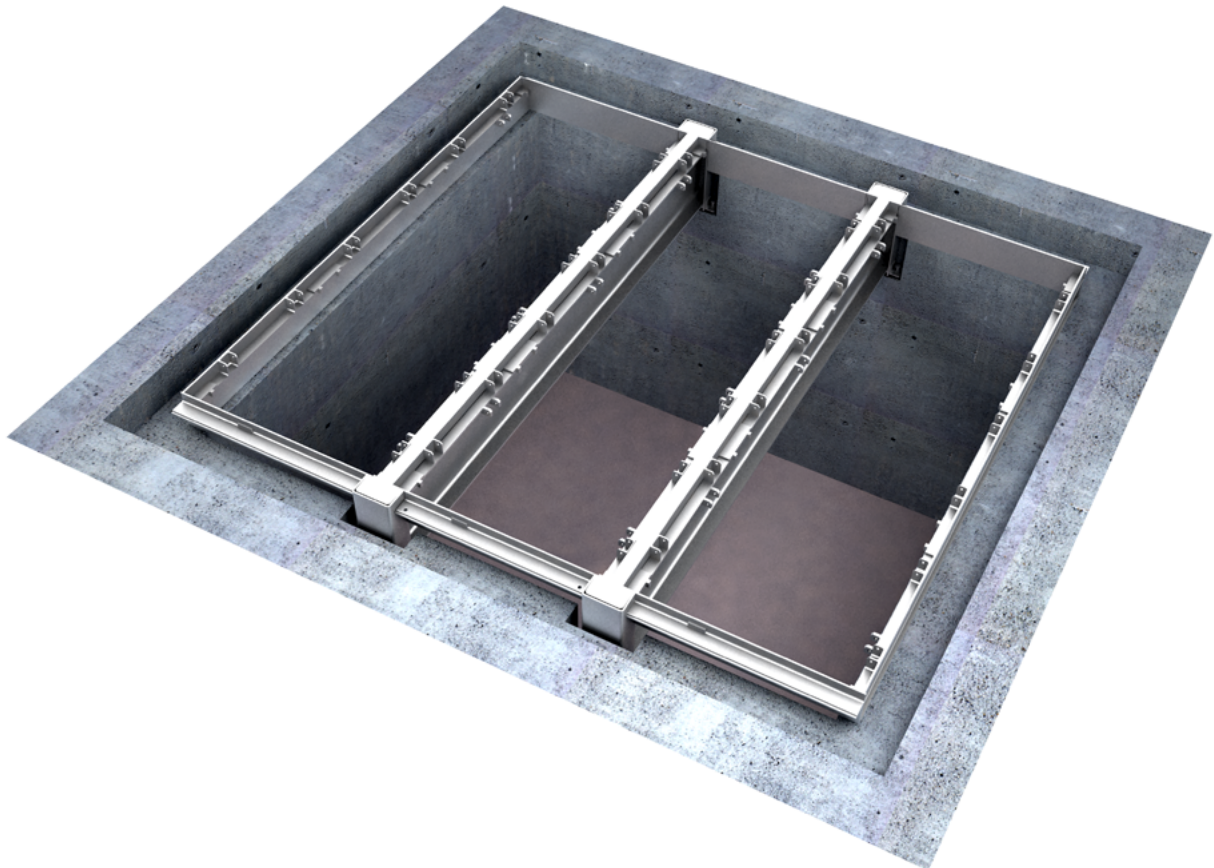

Notes

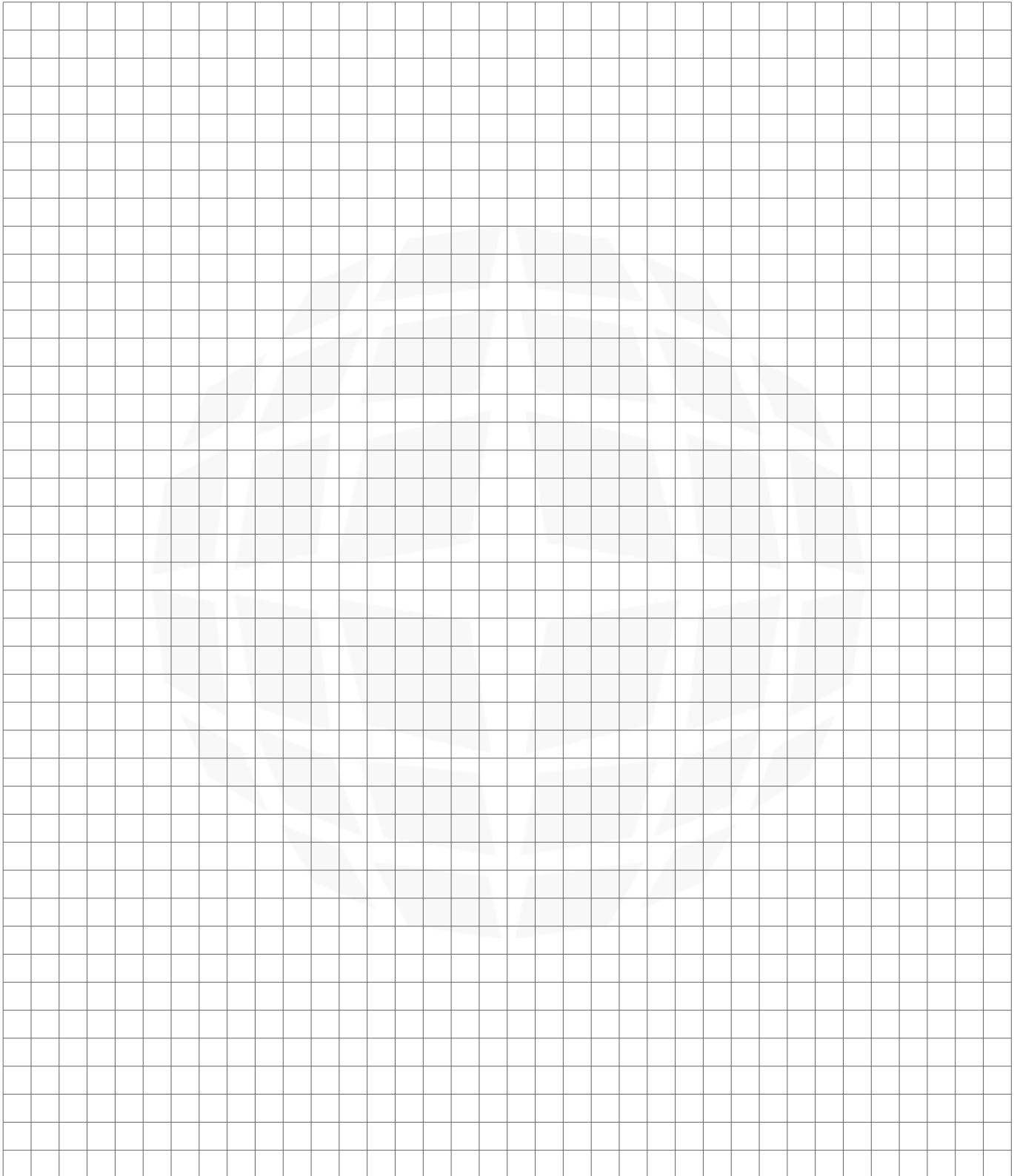

AQUERA® the modular range of gratings



- 130** A new modular range of gratings and frames
- 134** 1/2/3 parts grating and frames
- 136** Continuous duct gratings and frames
- 138** Multiple gratings with removable beams
- 140** Installation recommendations
- 144** Optional accessories for all modular products: safety grids and safety railings

AQUERA® range

Modular gratings solutions for drainage and ventilation

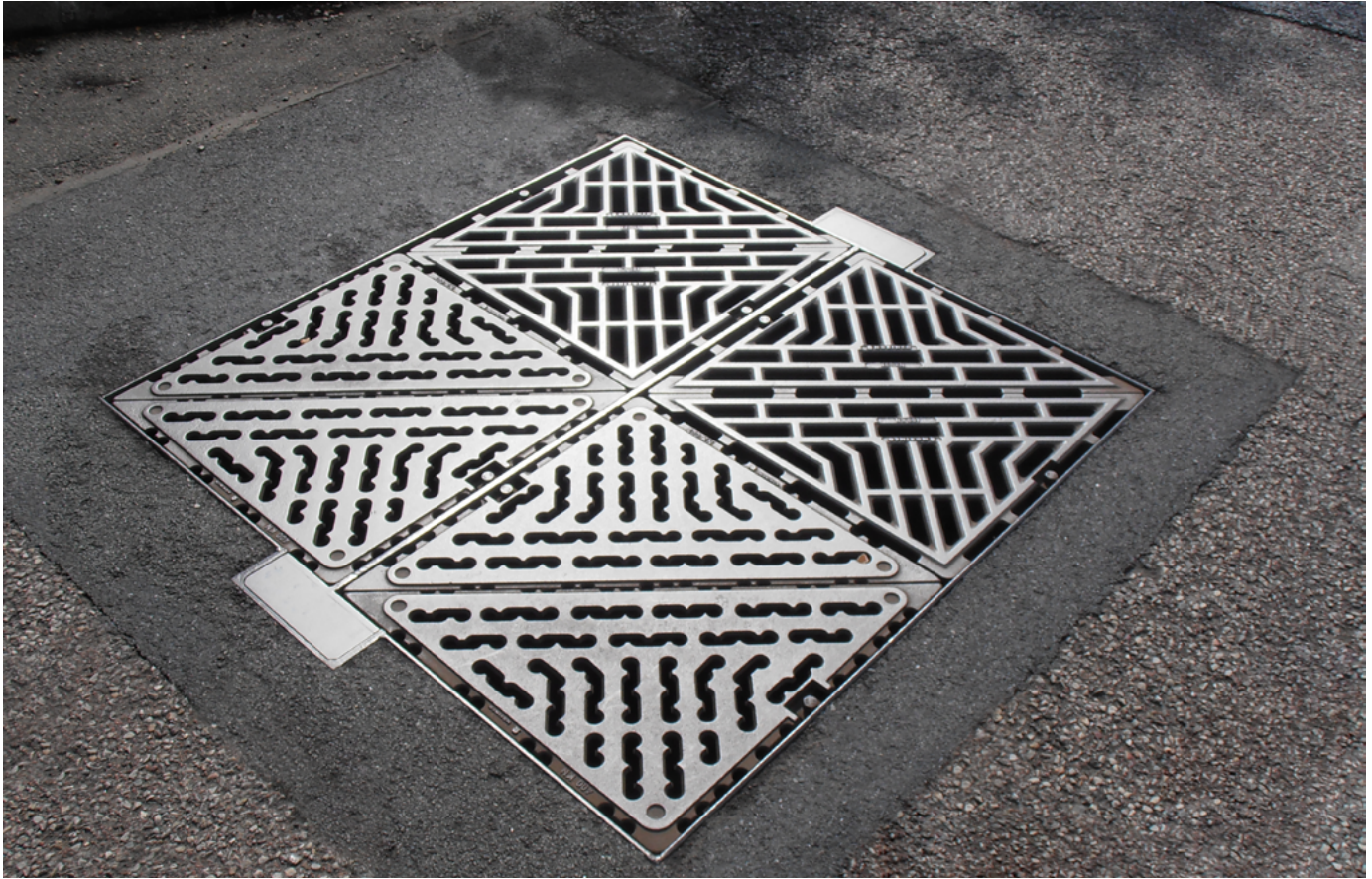

The urban environment is integral to our modern society. This has led to an increase in constructed areas with impervious surfaces such as footpaths, roadways and car parks which restrict effective drainage in normal rainwater conditions. In extreme weather conditions it can cause flooding which impacts significantly on society, threatening peoples lives, their property and the environment.

Many solutions have been sought after to render asphalt, brick blocks, etc, permeable but over time, their microstructure will eventually clog up because it is virtually impossible to maintain them over long periods.

In addition, large cities continue to expand and modernise their maze of underground tunnels used for public transport and shopping areas. These are literally «living areas» and require adequate ventilation.

Planning a network is in itself a daunting task. This is becoming ever more difficult when this network has to integrate itself into an already complex urban environment.

For example, a large ventilation of an underground rail system might have been installed a long time ago in a pedestrian area.

However, this pedestrian area may now have become a busy carriageway and it was virtually impossible to find an adequate solution.

This is where the strength of **EJ** comes in. With a worldwide presence of field engineers, listening to their client needs, we have designed and developed the unique **AQUERA** range. Together with the rain water management utilities and operators of large underground services, we have come up with the ultimate solution for maximum drainage and ventilation within urban areas. Whether the area is particularly prone to flash flooding or requires a «traffic ready» large ventilation area, EJ has designed the right solution with the **AQUERA** range of gratings, and adopted simple yet effective design concepts:

- **for maximum drainage capacity**, we have used our extensive experience- spanning several decades- developed for the ERMATIC multi-span covers. Our removable beamed access solutions are solid, enduring and easy to use.
- **for ultimate stability under modern urban traffic**, we have opted for a double triangular technology gratings.

AQUERA® range

Modular gratings solutions for drainage and ventilation

The use of modular elements for the construction of the AQUERA range of gratings, enables the construction of:

- 1, 2 or 3 part gratings,
- channel duct gratings,
- multiple units with removable beams for the largest drainage or ventilation requirements.

1/2/3 parts gratings

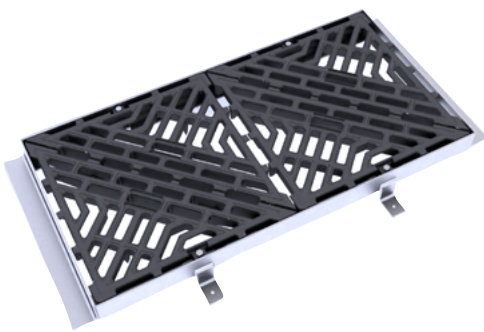

Gratings with removable beams

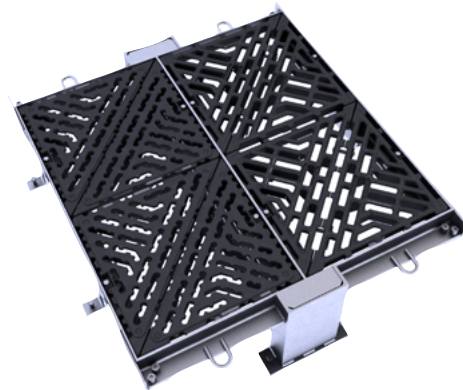

Duct grating

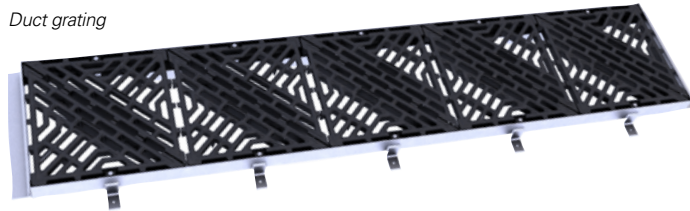

Security

Gratings are secured in their frame **by stainless steel bolts**. Each half grating is maintained in its frame lengthways in order to reduce its displacement and maintain tight tolerances. In option: coded head OTC bolts to prevent unauthorised entry or theft.



Silence and stability under road traffic

We adopt the 3-point suspension for ultimate stability and silence in use.

The two half gratings are loosely coupled one to another by means of an axis and Beta clips.



coupling pin with Beta clips

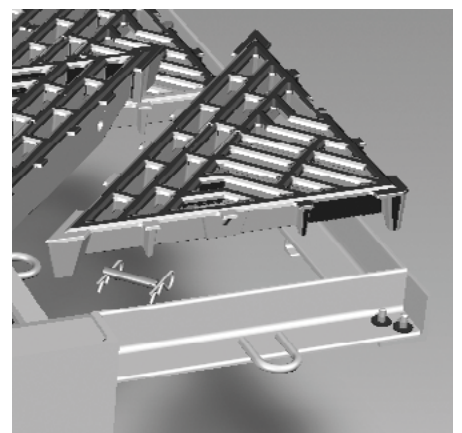

AQUERA® range

Modular gratings solutions for drainage and ventilation

Ease of installation

In order to facilitate the levelling of the product the hot dipped galvanised frame is provided with level adjusting bolts.

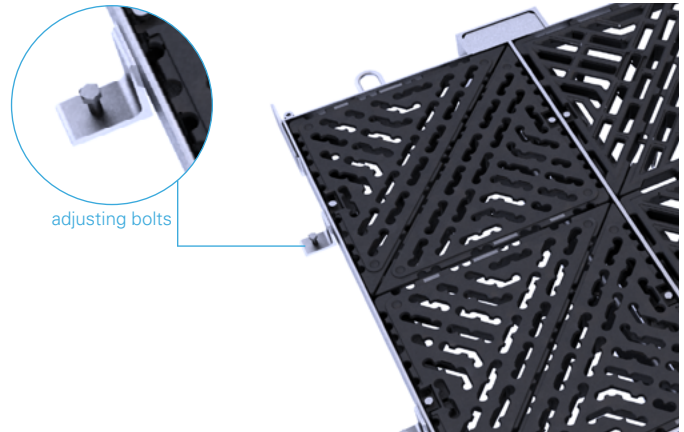

adjusting bolts

Maximum drainage and ventilation capacity

The grating slots have been specifically designed to maximise the water drainage, irrespective of the grating orientation when installed.



Standard slots dimensions

Standard type waterway 1470 cm² per unit

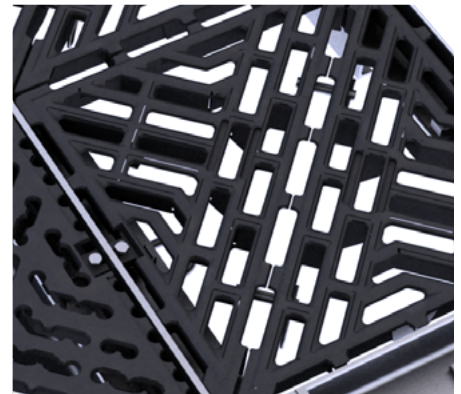

Suitable for small wheel vehicles, bicycles and wheel chairs. The grating design also exists with a **reduced slot dimension, pedestrian friendly gratings (LR type)** if the product needs to be installed in areas where small wheeled vehicles, bicycles or wheel chairs are in use.



Reduced slot, pedestrian friendly gratings (LR type)

LR type waterway 833 cm² per unit

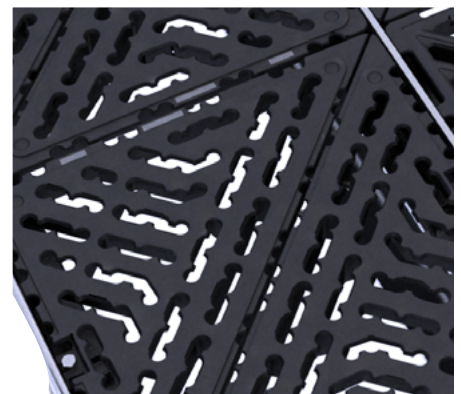



Scotland

Aquera® - 1/2/3 part gratings and frames 400 kN

Standard slot opening represented



Reduced slot opening represented

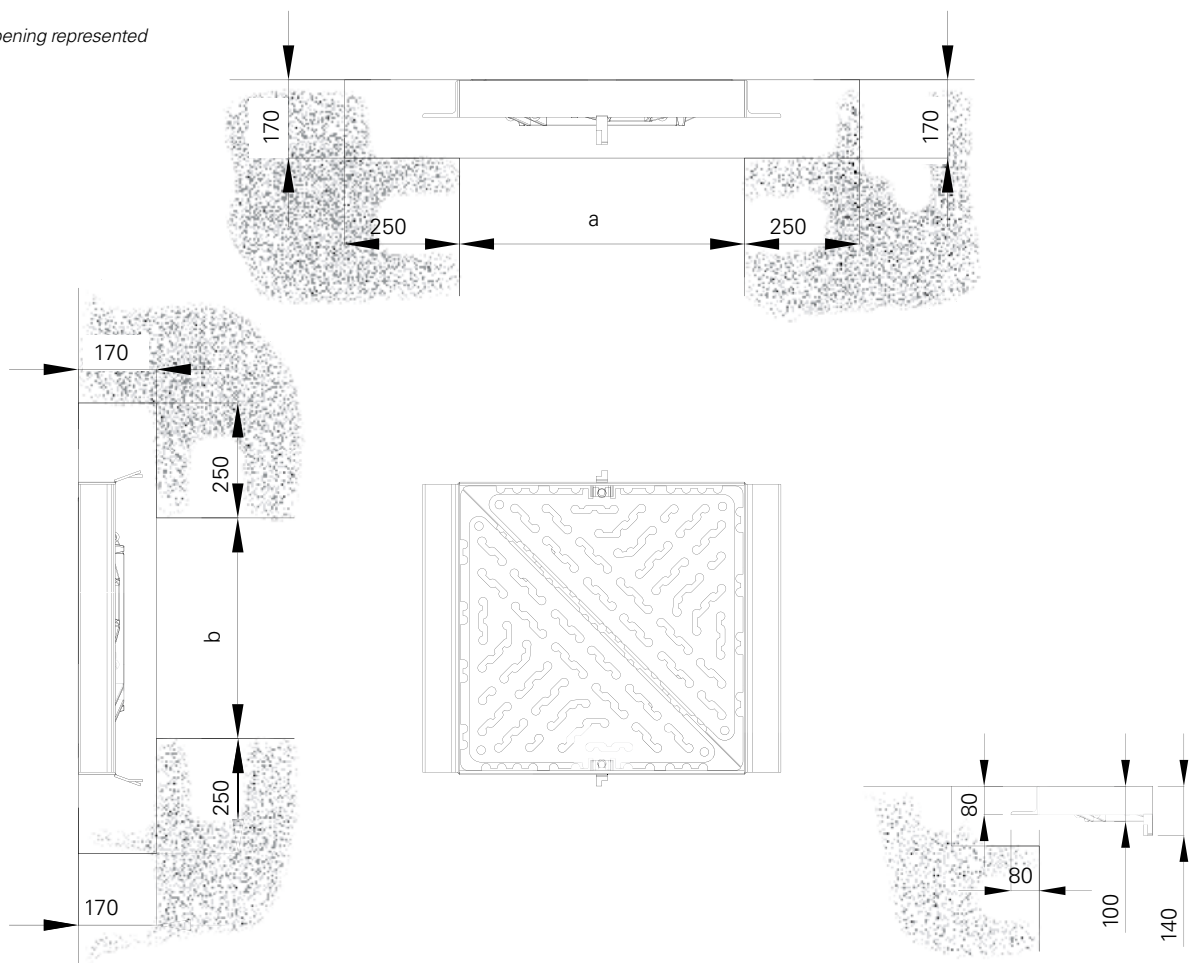

Aquera® - 1/2/3 part gratings and frames 400 kN

Area of installation

Group 3 according to EN 124.

For gully tops installed in the area of kerbside channels of roads which when measured from the kerb edge, extend a maximum of 0.5 m into the carriageway and a maximum of 0.2 m into the footway.

Specification

- Gratings: spheroidal graphite cast iron grating according to ISO 1083 (500-7) and EN 1563.
 - Frames: hot dip galvanised steel frame according to ISO 1459/60/61.
 - 3-point suspension flat gratings to ensure stability, silence and lack of vibration when in use.
 - Double triangular design with reversible gratings at 180°.
 - Gratings loosely coupled together by means of pin and beta clips.
 - Provided with frame level adjusting bolts to ease installation.
 - Gratings are secured in their frame by stainless steel bolts.
 - Grating bars are specially designed to provide maximum water drainage or ventilation.
 - Waterway/ventilation area:
 - 1470 cm² for each standard grating.
 - 833 cm² for each LR grating.
- To find out the grating entire waterway or ventilation areas, according to dimensions, you will have to calculate as follows:
- Standard slot opening N x 1470 cm²
 - Reduced slot opening N x 833 cm²
 - (N = Number of gratings)

clear opening axb (mm)	overall frame dim. length x width x height (mm)	number of gratings	reference
standard slot opening gratings with VCHC locking			
620 x 476	780 x 736 x 140	1	FC4G062048VCHC
1237 x 476	1397 x 736 x 140	2	FC4G124048VCHC
1854 x 476	2014 x 736 x 140	3	FC4G184048VCHC
standard slot opening gratings with VOTC locking system			
620 x 476	780 x 736 x 140	1	FC4G062048VOTC
1237 x 476	1397 x 736 x 140	2	FC4G124048VOTC
1854 x 476	2014 x 736 x 140	3	FC4G184048VOTC
reduced slot opening gratings with VCHC locking			
620 x 476	780 x 736 x 140	1	FC4G062048VCLR
1237 x 476	1397 x 736 x 140	2	FC4G124048VCLR
1854 x 476	2014 x 736 x 140	3	FC4G184048VCLR
reduced slot opening gratings with VOTC locking			
620 x 476	780 x 736 x 140	1	FC4G062048VOLR
1237 x 476	1397 x 736 x 140	2	FC4G124048VOLR
1854 x 476	2014 x 736 x 140	3	FC4G184048VOLR

Technical file

- See our installation guideline at the end of this section.

Options

- Reduced grate slot opening design of grates suitable for small wheeled vehicles, bicycles or wheel chairs.
- VOTC security coded head locking system



Reduced slot, pedestrian friendly gratings (LR type)



OTC bolt

Aquera® - Continuous duct gratings and frames

400 kN

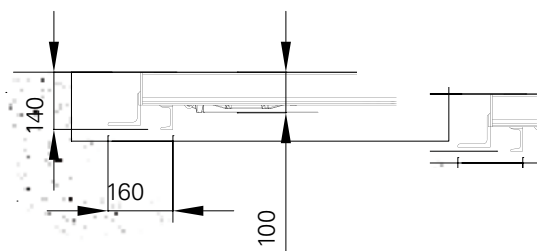
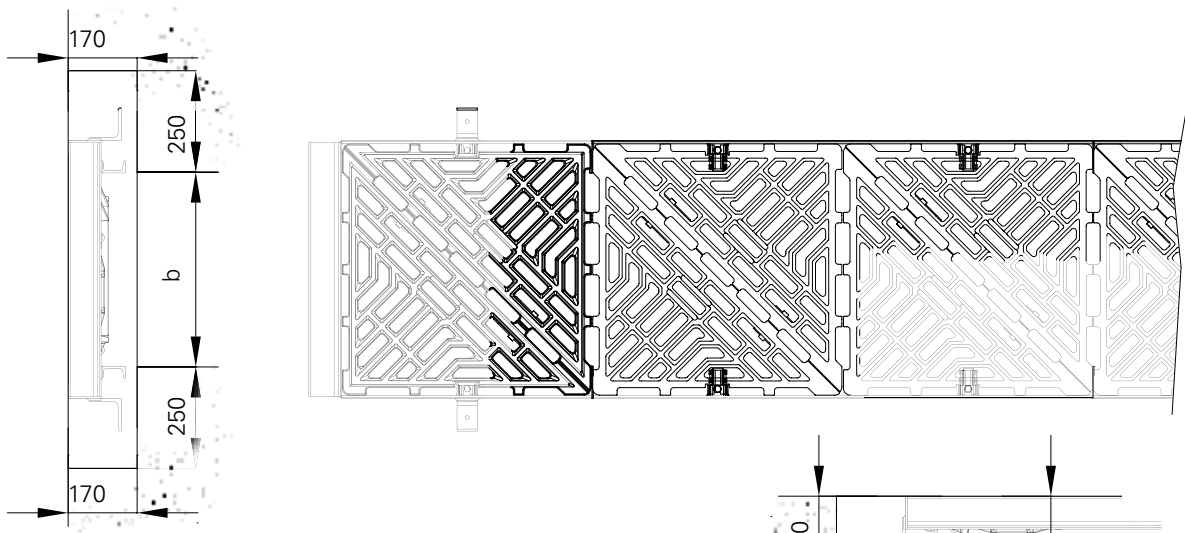
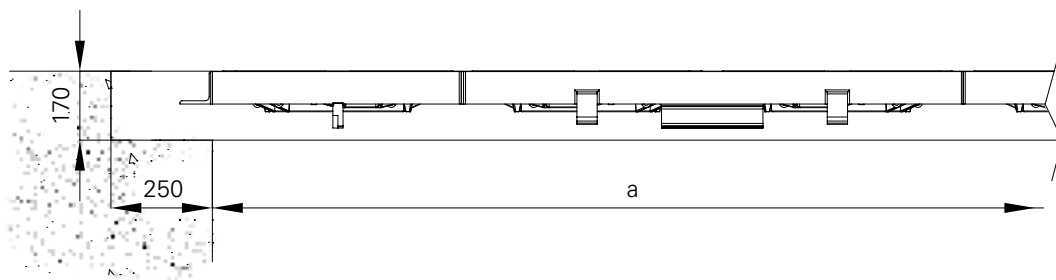
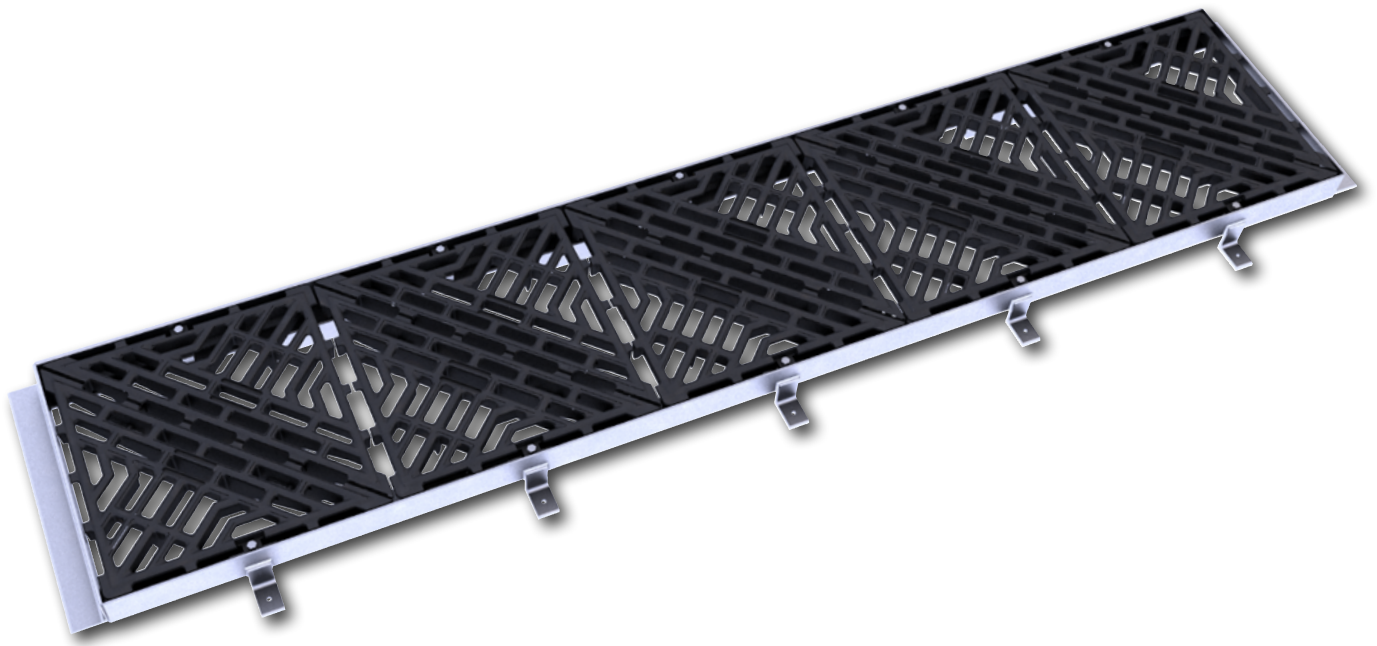

Aquera® - Continuous duct gratings and frames

400 kN

Area of installation

Group 3 according to EN 124.

For gully tops installed in the area of kerbside channels of roads which when measured from the kerb edge, extend a maximum of 0.5 m into the carriageway and a maximum of 0.2 m into the footway.

Specification

- Gratings: spheroidal graphite cast iron grating according to ISO 1083 (500-7) and EN 1563
 - Frames: hot dip galvanised steel frame according to ISO 1459/60/61
 - 3-point suspension flat gratings to ensure stability, silence and lack of vibration when in use.
 - Double triangular design with reversible gratings at 180°.
 - Gratings loosely coupled together by means of pin and beta clips
 - Provided with frame level adjusting bolts to ease installation.
 - Gratings are secured in their frame by stainless steel bolts.
 - Grating bars are specially designed to provide maximum water drainage or ventilation
 - Waterway/ventilation area:
 - 1470 cm² for each standard grating
 - 833 cm² for each LR grating.
- To find out the grating entire waterway or ventilation areas, according to dimensions, you will have to calculate as follows:
- Standard slot opening N x 1470 cm²
 - Reduced slot opening N x 833 cm²
 - (N = Number of gratings)

clear opening axb (mm)	overall frame dim. length x width x height (mm)	number of gratings	reference
standard slot opening gratings with VCHC locking system			
2471 x 476	2631 x 736 x 140	4	FC4G247048VCHC
3088 x 476	3248 x 736 x 140	5	FC4G309048VCHC
3705 x 476	3865 x 736 x 140	6	FC4G371048VCHC
4322 x 476	4482 x 736 x 140	7	FC4G432048VCHC

For longer dimensions you can apply the following formula

$$\text{Clear opening } a = (n \times 617) + 3$$

$$b = 476$$

Overall dimensions

$$\text{length} = (n \times 617) + 163$$

$$\text{width} = 736$$

$$\text{height} = 140$$

n= number of gratings

Different variations are available:

FC4G (a x b) VOTC ex : **FC4G247048 VOTC**
for standard slot opening grating with **VOTC** locking system

FC4G (a x b) VCLR ex : **FC4G247048 VCLR**
for reduced slot opening grating with **VCHC** locking system

FC4G (a x b) VOLR ex : **FC4G247048 VOLR**
for reduced slot opening grating with **VOTC** locking system

Technical file

- See our installation guideline at the end of this section.

Options

- Reduced grate slot opening design of grates suitable for small wheeled vehicles, bicycles or wheel chairs.
- VOTC security coded head locking system



Reduced slot, pedestrian friendly gratings (LR type)



OTC bolt

Aquera® - Multiple gratings with removable beams

400 kN

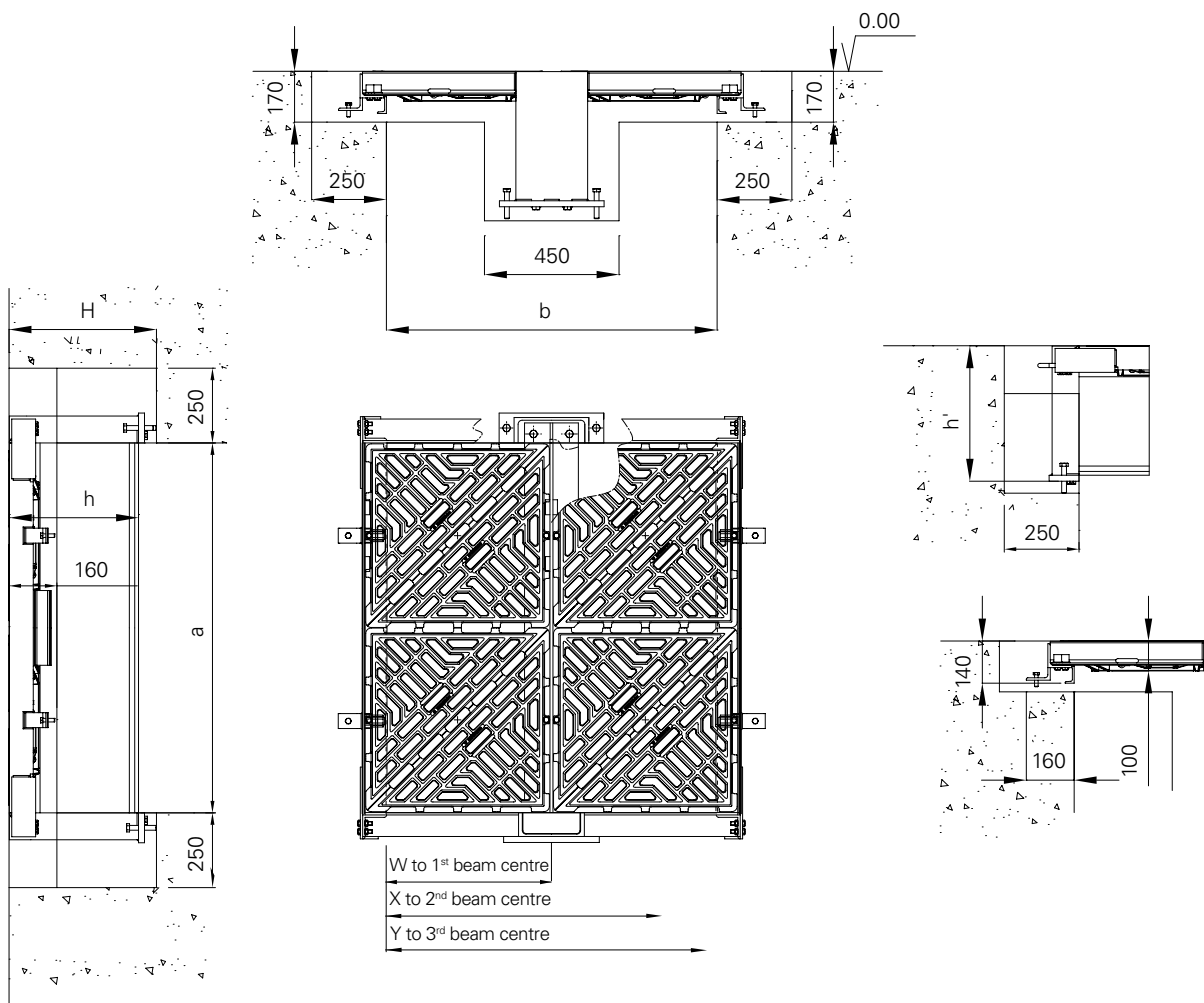
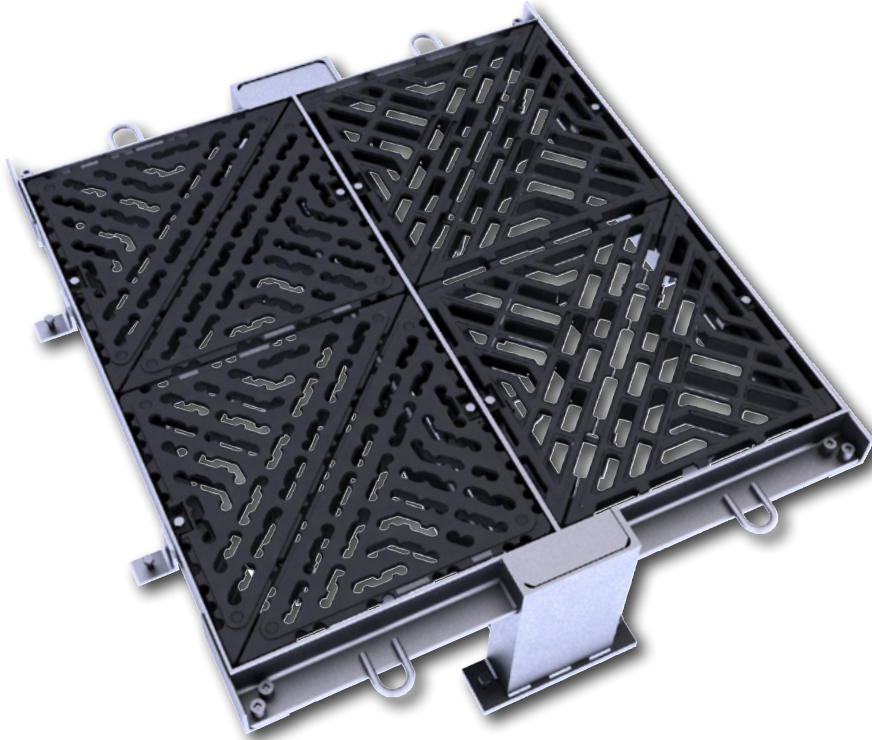

Aquera® - Multiple gratings with removable beams 400 kN

clear opening (a) mm	(b) mm	1106	1736	2366	2996	3626	4256	4886	5516	6146	beam used
	covers	2	3	4	5	6	7	8	9	10	
1237	2	1 beam	2 beams	3 beams	4 beams	5 beams	6 beams	7 beams	8 beams	9 beams	IPE360 (h=430)
1854	3	1 beam	2 beams	3 beams	4 beams	5 beams	6 beams	7 beams	8 beams	9 beams	IPE360 (h=430)
2471	4	1 beam	2 beams	3 beams	4 beams	5 beams	6 beams	7 beams	8 beams	9 beams	IPE360 (h=430)
3088	5	1 beam	2 beams	3 beams	4 beams	5 beams	6 beams	7 beams	8 beams	9 beams	IPE400 (h=470)
3705	6	1 beam	2 beams	3 beams	4 beams	5 beams	6 beams	7 beams	8 beams	9 beams	IPE400 (h=470)
4322	7	1 beam	2 beams	3 beams	4 beams	5 beams	6 beams	7 beams	8 beams	9 beams	IPE450 (h=520)
4939	8	1 beam	2 beams	3 beams	4 beams	5 beams	6 beams	7 beams	8 beams	9 beams	IPE500 (h=570)
beam center W, X, Y		553	1183	1813	2443	3073	4333	4963	5593	6223	

Product references : **FC4G** : (a in cm) (b in cm)

Example : a=1237mm b=1736mm = FC4G123174VCHC for standard slot opening grating

Overall dimensions : (a+160mm) x (b+260) x h+30 (frame height = 140mm) - For other dimensions: please enquire

Different variations are available:

FC4G (a x b) VOTC ex: **FC4G123174 VOTC** for standard slot opening grating with **VOTC** locking system

FC4G (a x b) VCLR ex: **FC4G123174VCLR** for reduced slot opening grating with **VCHC** locking system

FC4G (a x b) VOLR ex: **FC4G123174VOLR** for reduced slot opening grating with **VOTC** locking system

Area of installation

Group 3 according to EN 124.

For gully tops installed in the area of kerbside channels of roads which when measured from the kerb edge, extend a maximum of 0.5 m into the carriageway and a maximum of 0.2 m into the footway

Standard slot opening N x1470 cm²
Reduced slot opening N x 833 cm²
(N = Number of gratings)

Technical file

- See our installation guideline at the end of this section.

Specification

- Gratings: spheroidal graphite cast iron grating according to ISO 1083 (500-7) and EN 1563
- Frames: hot dip galvanised steel frame according to ISO 1459/60/61
- 3-point suspension flat gratings to ensure stability, silence and lack of vibration when in use
- Double triangular design with reversible gratings at 180°.
- Gratings loosely coupled together by means of pin and beta clips.
- Provided with frame level adjusting bolts to ease installation
- Gratings are secured in their frame by stainless steel bolts
- Grating bars are specially designed to provide maximum water drainage or ventilation
- Waterway/ventilation area:
1470 cm² for each standard half grating.
833 cm² for each LR half grating.

To find out the grating entire waterway or ventilation areas, according to dimensions, you will have to calculate as follows:

Options

- Reduced grate slot opening design of grates suitable for small wheeled vehicles, bicycles or wheel chairs.
- VOTC security coded head locking system



Reduced slot, pedestrian friendly gratings (LR type)



OTC bolt

Aquera® range

Installation recommendations: 1/2/3 part gratings and frames

Handling

- The product is delivered assembled as one complete unit to site (items up to 3gratings).
- In order to handle the unit, use a double chain equipped with lifting hook.

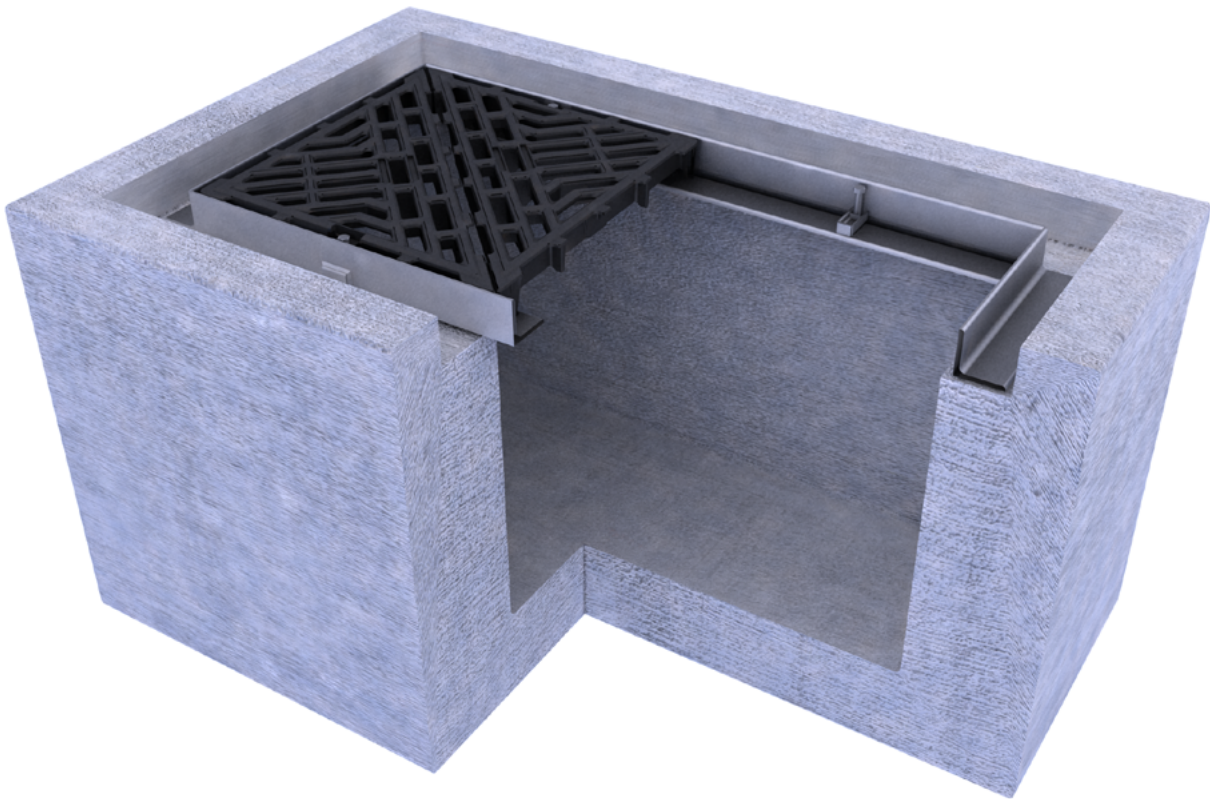

Installation

- Prepare the rebate according to the drawing provided.
- Correctly centre the frame within the rebate
- Shim to the correct level by using packers underneath the frame.
- Shutter the gap between the bottom of the frame and the concrete of the chamber.
- Position the gratings for the frames and lock them.

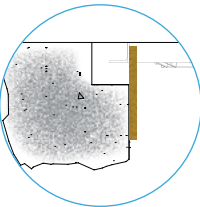

Shuttering

- Force the grout beneath the frame.
- Fill in the rebate in successive layers.
- **CAUTION:** If there is insufficient time to allow the concrete to fully cure before trafficking, use a rapid setting grout.

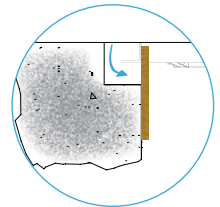

Aquera® range

Installation recommendations: continuous duct gratings and frames

Handling

- The product is delivered assembled as one complete unit to site according to the continuous duct size.
- In order to handle the cover, use a double chain equipped with a lifting hook.

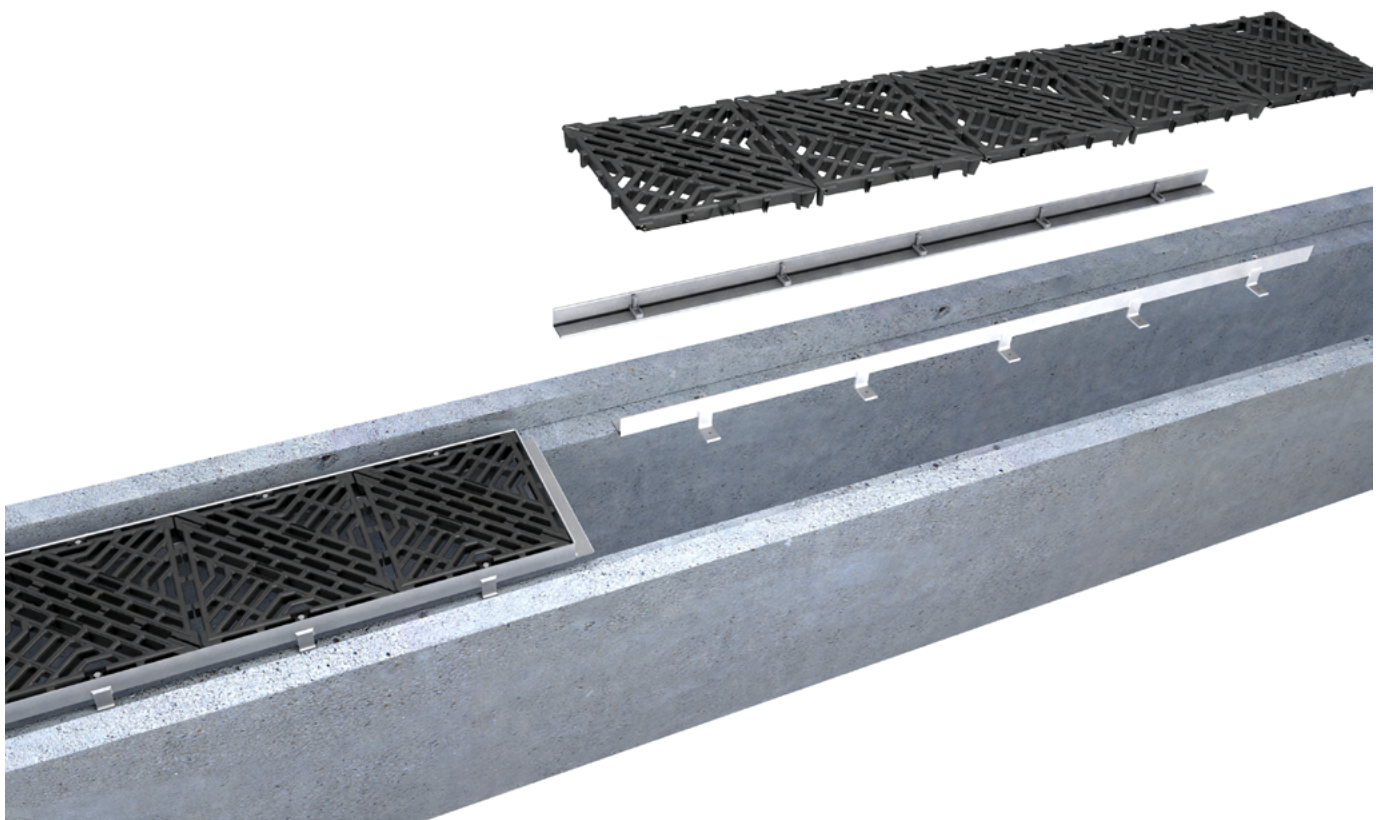

Installation

- Check the rebate according to the drawing provided.
- Correctly centre the cover and the frame within the rebate.
- Assemble the parts of the frame by means of the screw provided on this purpose.
- Shim to the correct level by using packers underneath the frame.
- Position the gratings for the frames and lock them.

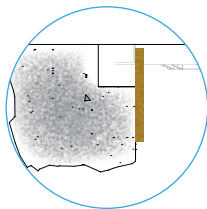

Shuttering

- Force the grout beneath the frame.
- Fill in the rebate in successive layers.
- **CAUTION:** If there is insufficient time to allow the concrete to fully cure before trafficking, use a rapid setting grout.

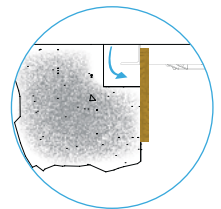

Aquera® range

Installation recommendations: multiple gratings with removable beams

Installation

- Prepare the rebate according to the drawing provided.
- Place the first element (beam box + extremity plate) in the rebate **(1a,1b)**.
- Adjust level by means of the levelling screws provided on this purpose.
- Install the extremity plates into the rebate with the levelling screws assembled with the frame and adjust level **(2)**.
- Position the first beam **(3)**.
- Screw the beam into its box with the screws provided on this purpose.
- Adjust level with the levelling screws.
- If the item is provided with several beams , repeat the last three actions.

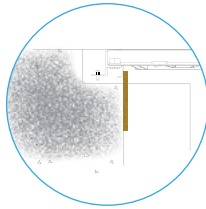

- To finalise, install the next beam and adjust it using the braces previously installed
- Adjust and fix the extremity plates.**(1b)**
- Install the gratings on the frames and lock them.
- Adjust and fix to the frame.

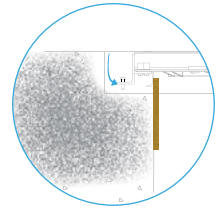

Shuttering

- To proceed with the formwork, do not remove all the gratings, but only 1 or 2 units, in order to access below side of the product.

Formwork

- **Caution:** the boxes mustn't be infilled with concrete.
- Replace the gratings in the frame.
- Carefully fill concrete below frame until it's full.
- Fill the rebate.
- **Caution:** If the concrete curing time can't be followed for any reason, we recommend to use a fast curing concrete.

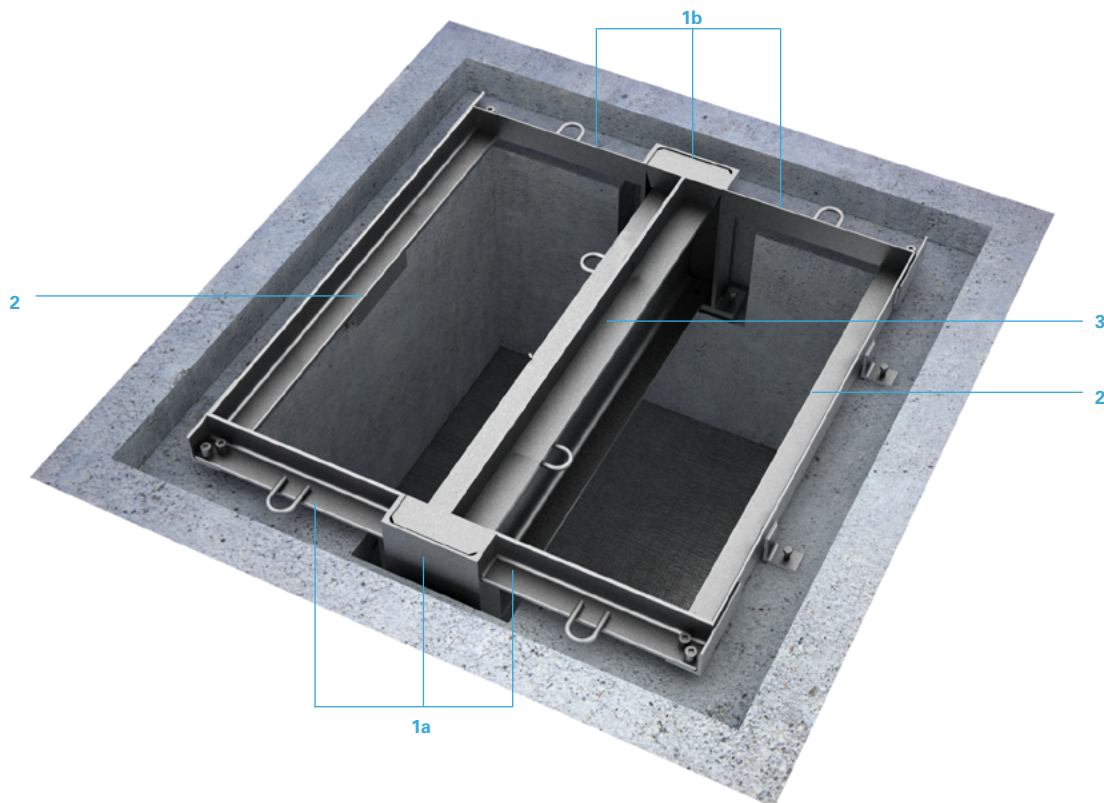



Madrid - Spain

Optional accessories for all modular products

Safety grids and safety railings

Safety and protection grids

Safety is a fundamental core value for **EJ**.

For this reason, **EJ** does not compromise when designing and manufacturing safety grids.

Handling, opening, closing, testing, dismantling, etc. will be

achieved easily and safely, in conformance with Health and Safety regulations.

Our experts will listen and guide you in choosing the right safety grid for your designated access and safety strategy.

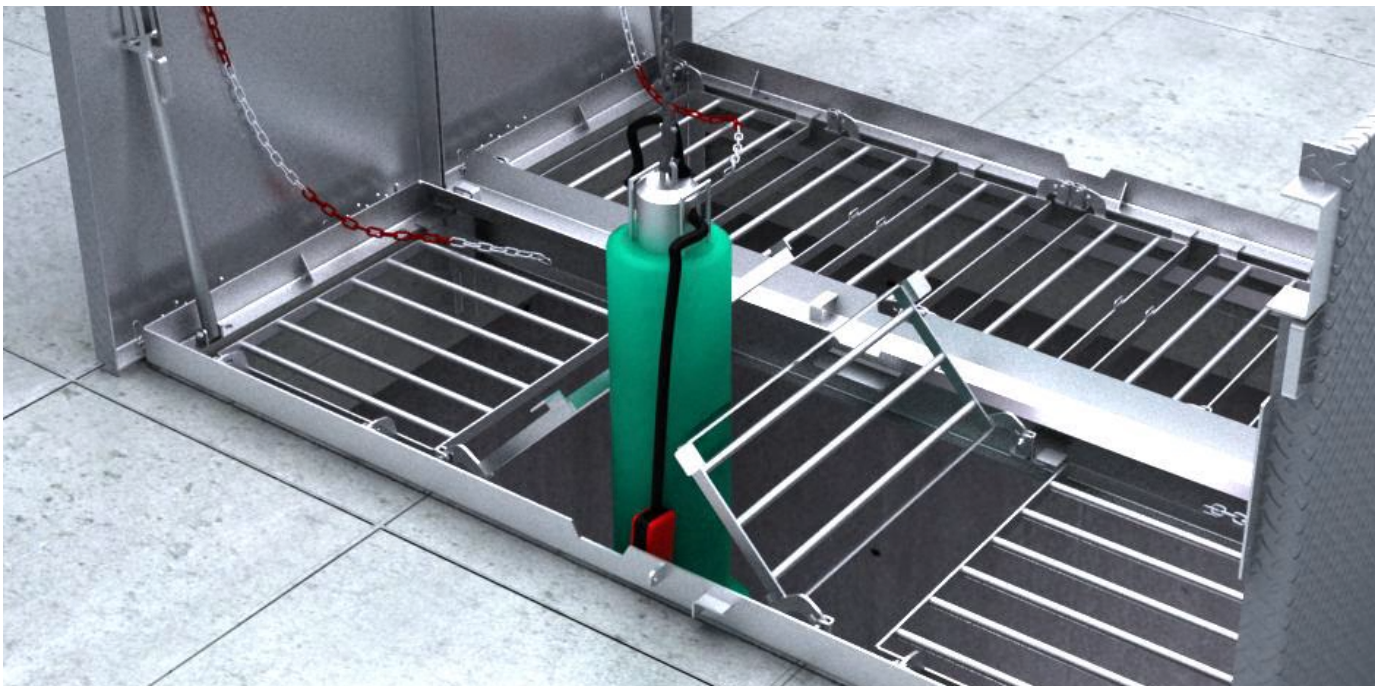

Specifications

- Resistance 150 or 300 kg
- 90° opening
- One man operation (lifting effort less than 25 kg)
- Lockable on request (padlock not supplied)
- Removable
- Delivered with a lifting chain
- Assembled on a product or wall chamber mounting option

Jail bar type grid



Walk on grid

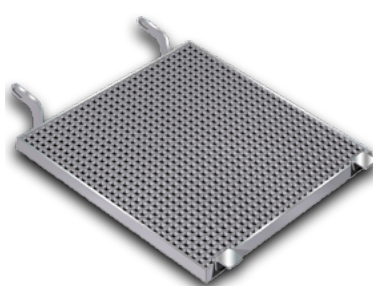

Mesh type grid to be fixed to the wall chamber

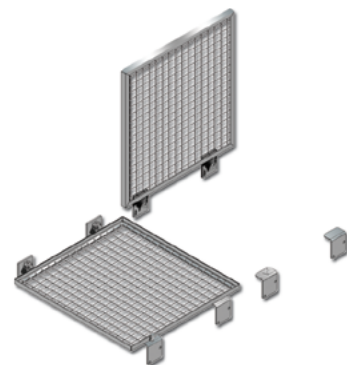

Optional accessories for all modular products

Safety grids and safety railings

2 parts grid :

suited for pump removal, when two pumps are positioned along the chambers shortest edge.



Grids with secondary hatch:

Allows access to an equipment without opening the grid completely.

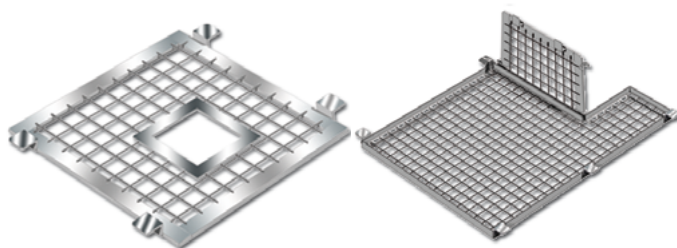

Grid with jail bar blocking at 90°



Safety railings

A safety and protection railing is necessary to avoid a person directly walking into the opening stair case.

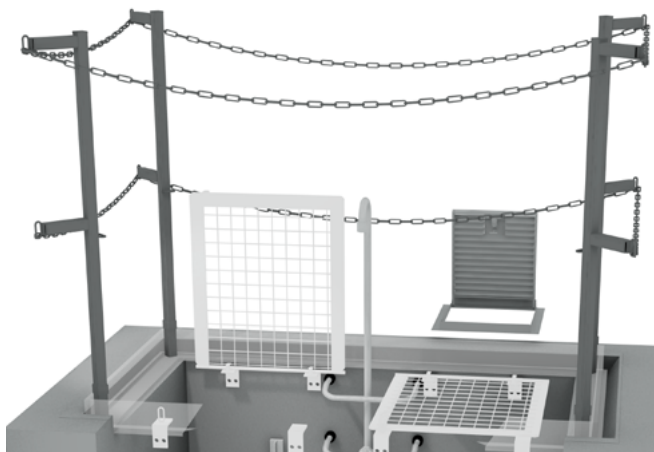

Notes

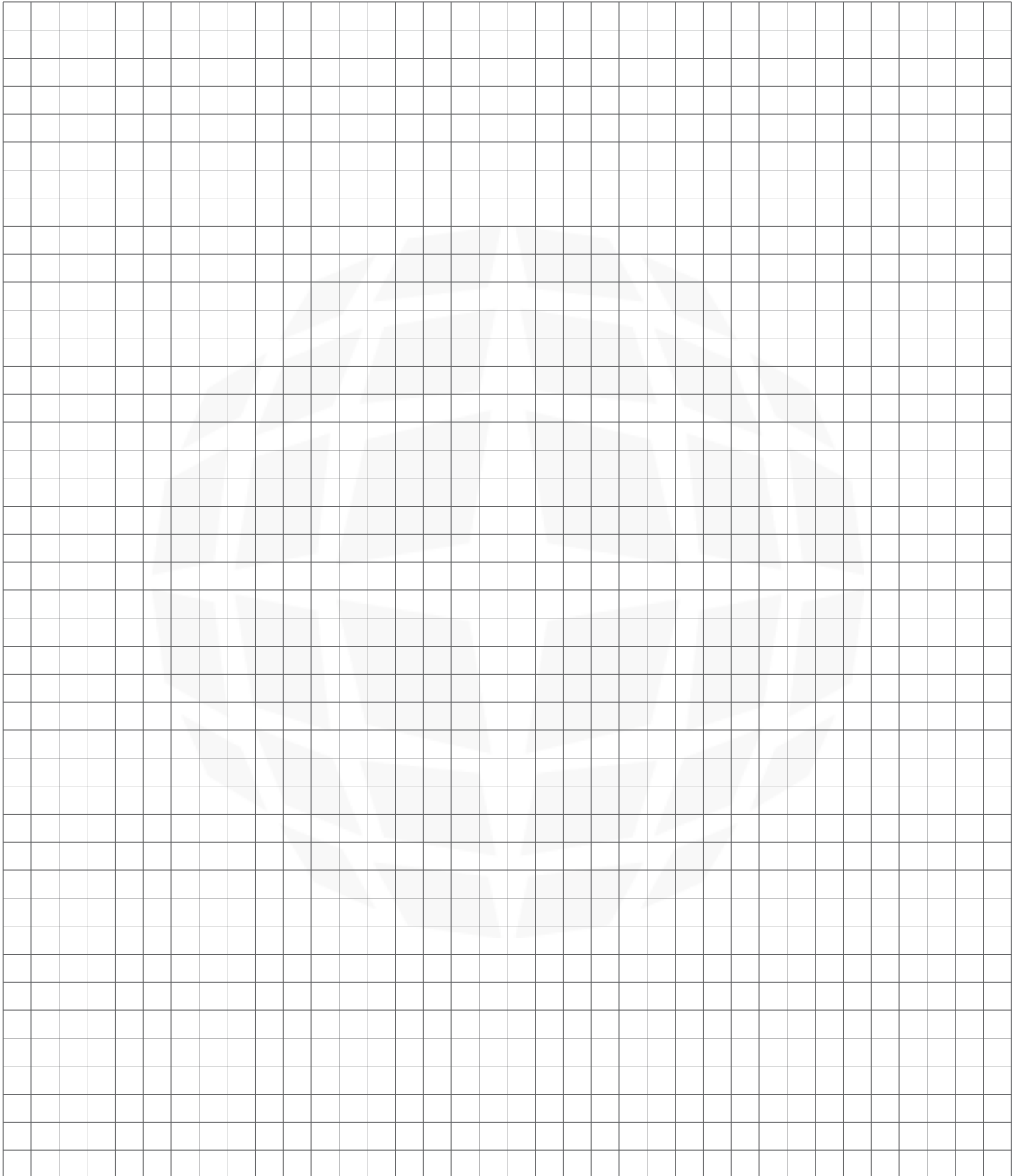





ej

ejco.com



Americas

+1 800 874 4100

EMEA

Europe, Middle East
and Africa

+33 344 08 28 00

Asia-Pacific

+61 73216 5000

ZI de Marivaux
Saint Crépin Ibouvillers
BP 50409 - 60544 Méru cedex - France
tel +33 3 44 08 28 00
fax + 33 3 44 08 28 05
emea.sales@ejco.com

Registered
marks



NORINCO®
TELECOM®
SELFLEVEL®
ERMATIC®
CHILDSAFETY®

NORGUSS®
CABLECOM®
NORLONG®
MAXIMO®
AQUERA®

**Ermatic® range and
Other Modular Solutions**
EJ ® 05/2023